

CONTENT

Safety Precautions P. 2	* Selecting the StyleP. 29
Control Panel & Terminals	...P. 6	* Setting the TempoP. 29
PreparationsP. 8	* Start the AccompanimentP. 30
* Setting UpP. 8	* Accompaniment Track Control	...P. 33
* ConnectionsP. 9	* Changing the Split Point of the	
Earphone and Audio outputP. 9	Accompaniment TrackP. 35
MIDI input/outputP. 9	Registration MemoryP. 36
Listening to the Demo SongsP.	* Register Panel SettingP. 36
Basic OperationP. 12	* Recalling the Registered Panel Setting	10.....P. 37
Playing the PianoP. 14	* Accompaniment Freeze Function	...P. 37
* Selecting and Playing a Voice	...P. 14	Song RecordingP. 38
PercussionP. 15	* Melody Track RecordingP. 38
* Keyboard Split ModeP. 16	* Accompaniment Track Recording	...P. 40
Changing the Split Voice and Relative		* Melody & ACMP Tracks Playback	...P. 42
ParametersP. 17	Practice FunctionP. 43
* Touch ResponseP. 18	* Minus Channel ModeP. 44
* Dual VoiceP. 18	* Repeated PlaybackP. 44
Selecting the Relative Parameters of Dual		Whole FunctionP. 45
.....P. 19	* Common FunctionsP. 46
* Harmony/EchoP. 20	Keyboard VolumeP. 46
Selecting the Harmony / Echo	...P. 20	OctaveP. 46
* SustainP. 21	Reverb LevelP. 46
* SostenutoP. 21	Chorus LevelP. 47
* SoftP. 21	PanP. 47
* TransposeP. 22	Voice SetP. 47
Number EffectP. 23	Accompaniment VolumeP. 47
* Using Number EffectP. 23	Touch SensitivityP. 48
* Changing the Reverb Effect	...P. 23	Minus ChannelP. 48
Selecting the Reverb Style	...P. 23	MetronomeP. 48
Setting the Reverb Return Level	...P. 24	PitchP. 48
* Changing Chorus EffectP. 25	* MIDI FunctionsP. 49
Selecting the Chorus Style	...P. 25	Send & ReceiveP. 49
Setting the Chorus Return Level	...P. 26	Keyboard OutputP. 49
* Selecting 3D EffectP. 26	AppendixP. 50
Using Auto AccompanimentP. 27	* Voice ListP. 50
* Selecting Accompaniment Mode	...P. 27	* Style ListP. 52
		* Drum Set TableP. 53
		* Technique SpecificationsP. 55

SAFETY PRECAUTIONS ...

■ Symbols

Various symbols are used in this user's manual guide and on the product itself to ensure that the product is used safely and correctly and to prevent injury to the user and other persons as well as damage to property. Those symbols along with their meanings are shown below.

■ WARNING!

This indication stipulates matters that have the risk of causing death or serious injury if the product is operated incorrectly while ignoring this indication.

■ CAUTION!

This indication stipulates matters that have the risk of causing injury as well as matters for which there is the likelihood of occurrence of physical damage only if the product is operated incorrectly while ignoring this indication.

■ Symbol Examples

 This triangle symbol means that the user should be careful. (The example at left indicates electrical shock caution.)

 This circle with a line through it means that the indicated action must not be performed. Indications within or nearby this symbol are specifically prohibited. (The example at left indicates that disassembly is prohibited.)

 The black dot means that the indicated action must be performed. Indications within this symbol are actions that are specifically instructed to be performed. (The example at left indicates that the power plug must be unplugged from the electrical socket.)

—————  ! WARNING —————

■ Please use caution regarding the handling of the AC adaptor.

- Do not use a voltage other than the indicated power supply voltage. Use of a voltage other than that indicated may cause fire or electrical shock.

- If the power cord should become damaged (exposed wires, disconnection, etc.), purchase a new AC adaptor. Use of a damaged power cord may cause fire or electrical shock.

- Do not cut or damage the power cord. Also do not place heavy objects on top of it or subject it to excessive heat.

Damage to the power cord may cause fire or electrical shock.

● Do not attempt to shape the power cord subject to excessive bending, twisting or pulling. This may cause fire or electrical shock.

● Please use the adaptors specified for this instrument. Use of another adaptor may cause fire, electrical shock or malfunction.

■ Do not locate the instrument or its stand on an uneven or unstable surface.

* Locating the instrument on its stand on an uneven or unstable surface can cause it to fall, creating the danger of personal injury.

■ Do not place containers containing water or other liquids on the instrument.

 ● Do not place the following objects on the instrument. Placing such objects on the instrument may cause fire or electrical shock if they pick up and get inside the instrument.

● Containers filled with water or other liquids (including vases, potted plants, cups, cosmetics and medicines)

 ● Small metal objects (including hairpins, sewing needles and coins)

● Flammable objects

In the event a foreign object should happen to get inside the instrument, please take the following actions:

1. Turn power off.

2. Unplug the AC adaptor from the wall outlet.

 3. If there are any batteries loaded in the keyboard, remove them.

* Do not touch the batteries directly with your hands when removing them. They may be hot or battery fluid may be leaking from them.

4. Consult with the dealer where you purchase the keyboard or with an authorized service provider.

Do not disassemble or modify the instrument.

 ■ Never attempt to take apart or modify the instrument, its accessories, or separately sold options. Doing so may cause fire, electrical shock or malfunction. Consult your dealer concerning all inspection, adjustment or repair of internal components.

Do not use if there is an abnormality or malfunction.

 ■ * Do not use the instrument if there appears to be abnormalities such as the presence of smoke or abnormal odor. Also do not use the instrument if there appears to be malfunctions such as the power not coming on or sound not being produced. Use under such conditions may cause fire or electrical shock. In such cases, take the following actions immediately. Never attempt to repair the instrument yourself.

1. Turn power off.

2. Unplug the AC adaptor from the wall outlet.

 3. If there are any batteries loaded in the keyboard, remove them.

* Do not touch the batteries directly with your hands when removing them. They may be hot or battery fluid may be leaking from them.

4. Consult with the dealer where you purchased the keyboard or with an authorized service provider.

When the instrument has been dropped:

■ * In the case the instrument has been dropped or damaged, take the following actions.

 Continued use may cause fire or electrical shock.

1. Turn power off.

2. Unplug the AC adaptor from the wall outlet.

 3. If there are any batteries loaded in the keyboard, remove them.

* Do not touch the batteries directly with your hands when removing them. They may be hot or battery fluid may be leaking from them.



4. Consult with the dealer where you purchased the keyboard or with an authorized service provider.

■ Be careful of the bags around children.

- *. Never allow anyone to place the plastic bags of the instrument, its accessories, and its separately sold options over their heads. Doing so may cause suffocation. Particular cautions are required in homes with small children.

CAUTION

■ AC Adaptor

-  *. Do not locate the power cord in close proximity to heaters or other heating appliances. This may cause the cord to melt leading to possible fire or electrical shock.
-  *. When unplugging the AC adaptor from an electrical outlet, always make sure to pull on the adaptor itself and not the cord. Pulling excessively on the cord may cause it to be damaged or break leading to possible fire or electrical shock.
-  *. Do not touch the AC adaptor with wet hands when it is plugged in. This may cause electrical shock.
- *. When not using the instrument for an extended period such as when travelling, always make sure to unplug the AC adaptor from the electrical outlet for safety reasons.
- *. After use, turn off the power switch of the instrument and unplug the AC adaptor from the electrical outlet.

■ Batteries

- *. Improper battery use may cause batteries to rupture and leak. This may cause injury, malfunction of the instrument or discoloration of furniture and other articles that come into contact with battery fluid. Take care to observe the followings.
 - *. Install batteries so their polarity (+/-) matches that indicated on the instrument.
 - *. For safety and to prevent possible leakage of battery fluid, always make sure to remove batteries from the instrument when you do not plan to use it for long time.
- *. Always make sure that the batteries making up a set are all of the same type.
- *. Never combine the new batteries with old ones.
- *. Never dispose of batteries by incinerating them. Never short or disassemble batteries, and do not expose them to excessive heat.
- *. Replace lead batteries as soon as possible.
- *. Never attempt to recharge batteries.

■ Transport

-  *. When transporting the instrument, always make sure to unplug the AC adaptor from the electrical outlet and confirm that all other external connections have been disconnected. Only then should the instrument be transported. If the above is not done, the cord may be damaged leading to possible fire or electrical shock.

■ Care

-  *. Whenever caring, make sure to first unplug the AC adaptor from the electrical outlet. Also remove the instrument's batteries if battery power is being used.

■ Location

-  *. Never locate the instrument in an area subject to high humidity or heavy accumulation of dust. Doing so may cause fire or electrical shock.
- *. Never locate the instrument in an area subject to grease splatters or steam, such as in a kitchen or near a humidifier. Doing so may cause fire or electrical shock.

- Do not place keyboard on lacquered furniture.
 - *. The instrument's silicone rubber feet may eventually blacken or scar lacquered surfaces. Use felt cloths to insulate the feet preferably use an excellent musical instrument stand designed for your keyboard.
- Do not place heavy objects on the instruments.
 - *. Do not place heavy instruments on the instruments. This may cause the instrument to tip over or break resulting in injury.
- Volume
 - *. Very high volume levels can damage hearing. Avoid using the instrument at very high volume settings for long periods. Consult with a physician immediately if you experience impaired hearing or ringing in the ears.
- Liquid Crystal Display (LCD) Precautions
 - *. Avoid subjecting the keyboard's LCD to strong impact which can crack or break the LCD's glass creating the danger of personal injury.
 - *. Should the LCD glass ever crack or break, do not allow the liquid inside the LCD to come into contact with your skin which can cause inflammation and reddening.
 - *. Should the LCD liquid get into your mouth, immediately wash out your mouth with water and then consult a physician.
 - *. Should the LCD liquid get into your eyes or on your skin, immediately flush with water for at least 15 minutes and then consult a physician.
- Do not get onto the instrument or stand.*
 - *. Do not crawl on top of the instrument or its optional stand. Particular caution is required in homes having small children. This may cause the instrument or stand to tip over and break resulting in injury.
- Optional stand*
 - *. Carefully assemble the stand following the assembly instructions that come with it. Securely tighten all bolts, nuts, and fasteners, and make sure that you mount the instrument correctly onto the stand. Incorrectly insufficiently tightening screws, or incorrectly mounting the instrument onto the stand can cause the stand to tip over or the instrument to fall off the stand, possibly leading to injury.
 - * The stand is available as an option.

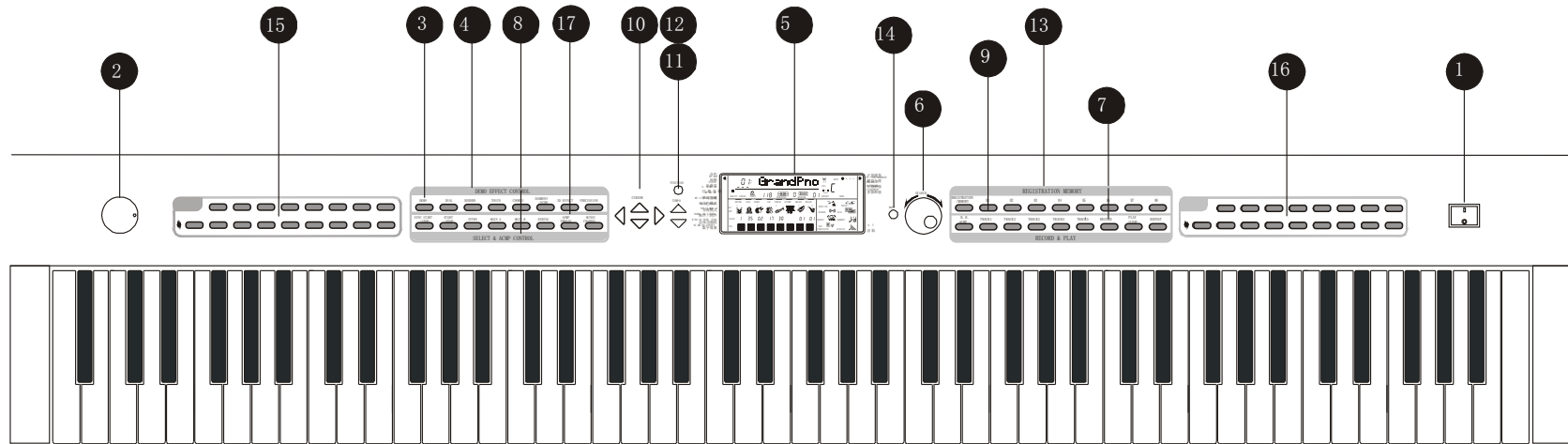

+ Control Board :

① POWER SwitchP.. 10	⑥ SEARCH dial15...	⑩ CURSOR buttonsP.. 12...
② MASTER VOLUME dialP.. 10	⑦ RECORD & PLAYBACKP.. 38	⑪ TEMPO buttonP.. 29
③ DEMO buttonP.. 10	! RECORD button 39	⑫ FUNCTION buttonP.. 12
④ EFFECT		! PLAY/ST OP button 10, 39, 42	⑬ REGISTRATION MEMORYP.. 36
! REVERB buttonP.. 23	! REPEAT buttonP.. 44	! MEMORY buttonP.. 37
! CHORUS buttonP.. 25	! MINUS CHANNEL buttonP.. 43	! M1~M8 buttonsP.. 37
! PERCUSSION buttonP.. 15	⑧ AUTO ACCOMP ANIMENTP.. 27	⑭ MODE button14.....P
! 3D EFFECT buttonP.. 26	! SYNC STAR T/STOPP.. 30	⑮ STYLE button29.....P
! TOUCH button18 P	! INTRO buttonP.. 30	⑯ VOICE buttonP.. 14
! DUAL button18.....P	! MAIN A /B31.....P	⑰ ACMP FREEZE buttonP.. 37
! HARMONY/ECHO buttonP.. 20	! ENDING button32.....P		
⑤ LCD screenP.. 12	! STAR T/STOP buttonP.. 30		
		⑨ TRACK buttonP.. 33		
		! ACMP B/S33..P		
		! TRACK ON/OFP.. 33		

External Terminals

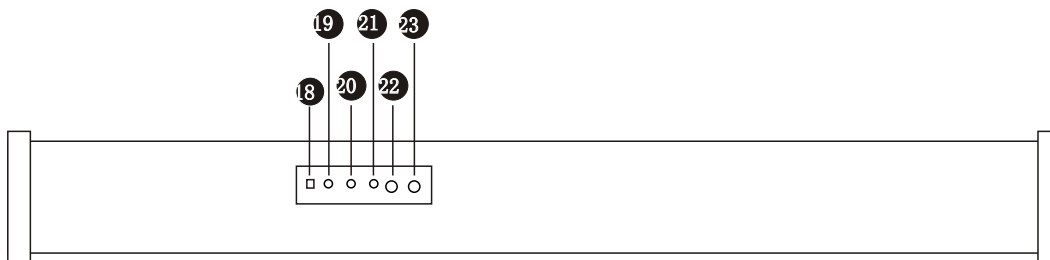

18 DC Adapter Jack.....	9.....	F
19 Headphone Jack.....	9.....	P
20 Soft /Sustain PedalJack	9.....	P
21 Sostenuto PedalJack	9.....	P
22 MIDI OUT	9.....	
23 MIDI IN	9.....	

■ Foot Pedals

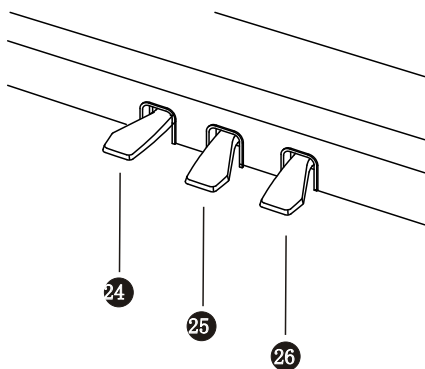

24 Soft Pedal.....	9, 21.....	P
25 Sostenuto Pedal.....	9, 21.....	P
26 Sustain Pedal.....	9, 21.....	P

NOTICE:

We have two versions of W8812B. In economy version, there is no pedal, however in deluxe version, all the pedals stated above will be there.

■ Music Stand

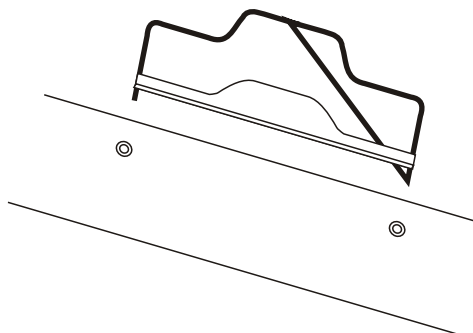

You can add one music stand to this instrument.

PREPARATIONS

■ Setting Up

W 8812B Economic Version

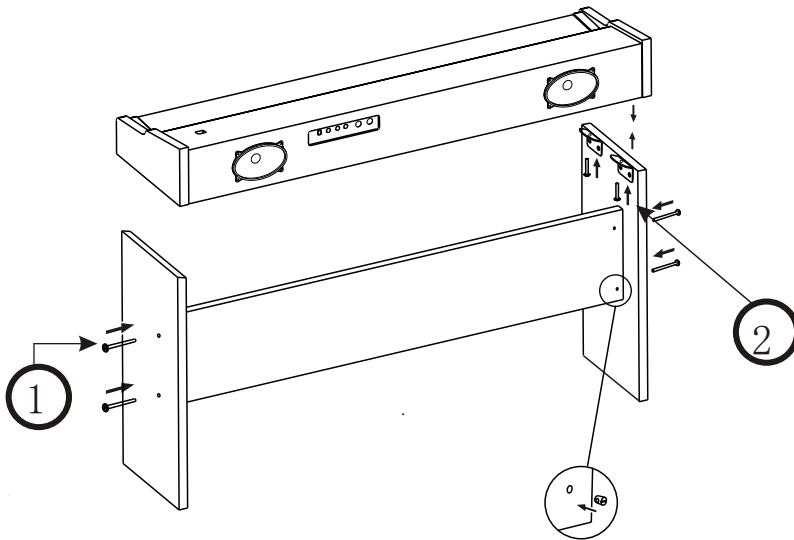

1. Fasten the left and right feet to the pedal rack with 2 bolts (M6x60).
2. Place the body onto the plank, and fix it with 4 zinc-gilded screws at each side as shown in the illustration.

W 8812B Deluxe Version

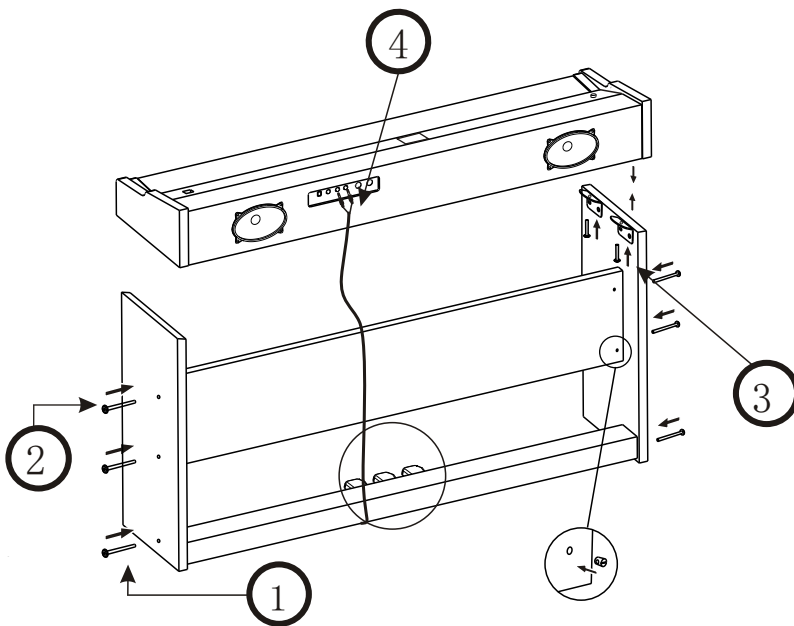

1. Fasten the left and right feet to the pedal rack with 2 bolts (M6x60).
2. Fasten the shelter board to the left and right feet with 4 bolts and screws (M6x60).
3. Place the body onto the plank and fix it with 4 zinc-gilded screws at each side as shown in the illustration.
4. Connect the cable of both pedals with the illustration.

■ Connections

Here are the most important jacks of this instrument. Please pay attention.

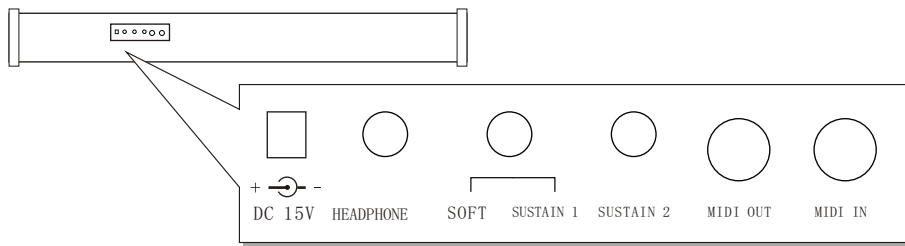

■ Power supply

Please use external power supply.

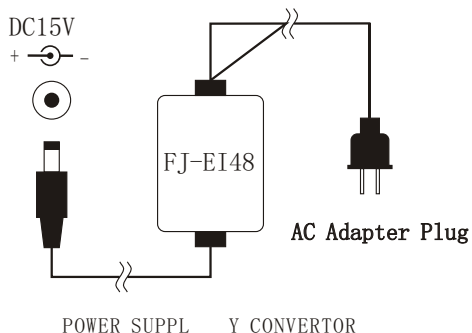

This instrument can use F J-EI48 Adapter by connecting the output terminal of the adapter with DC 15V power input jack and the input terminal with alternating current power.

■ Earphone and Audio output

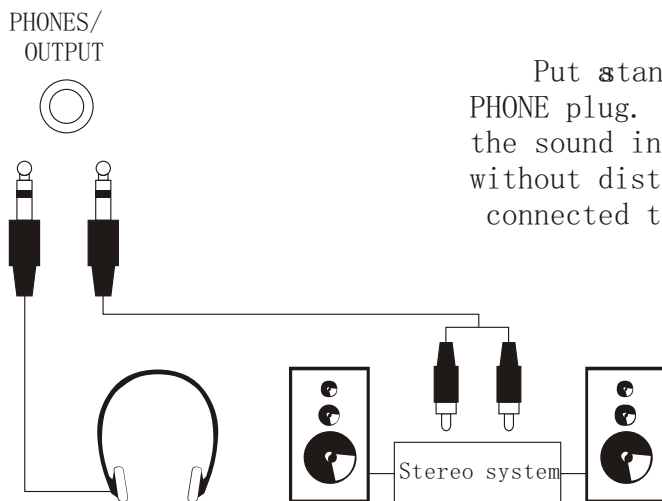

Put a standard earphone to connect the keyboard's PHONE plug. While connection is made, you only hear the sound inside the earphone and practice the music without disturbing the others. This plug can also be connected to the speaker to have a stereo system.

■ MIDI input/output



MIDI IN
Receive MIDI Data from the outside devices connected (e.g. Sequencer)

MIDI OUT
Send MIDI Data of this keyboard

LISTENING TO THE DEMO SONGS

■ *. Listento theMusic of the Memory

After installationyou may play thisinstrument. Justexperience itsexcellent performance. There are four Demos.

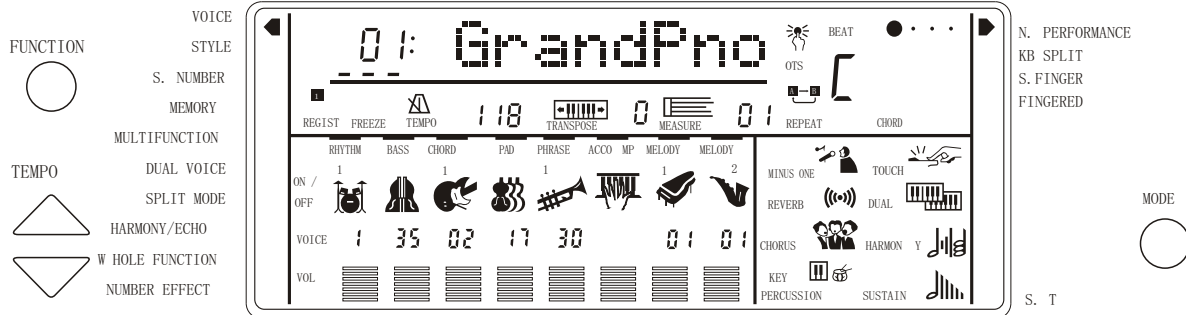

- 1. Tune on the POWER



POWER

- 2. Adjust the MASTER VOLUME dial to 1/4 circle. You can also adjust it during the playback

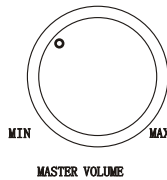

MASTER VOLUME

. It's always a good idea to set the master volume at a relatively low level before playing.

- 3. Press the [DEMO] button

Press the [DEMO] button, this instrument will play the music automatically. The name of the first song will appear on the screen. This instrument comes with 6 songs in memory while they will play order and circular before being stopped.

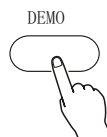

- 4. To Select other demos

During the demo playback, you can adjust the [SEARCH] dial to select other demo songs. Press [PLAY/STOP] button, and this instrument will play from the beginning of the song you have selected.

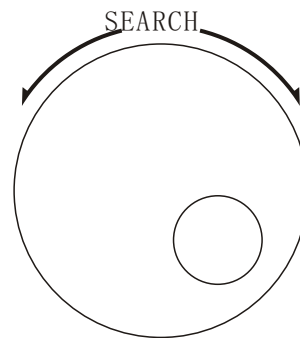
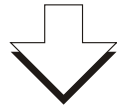
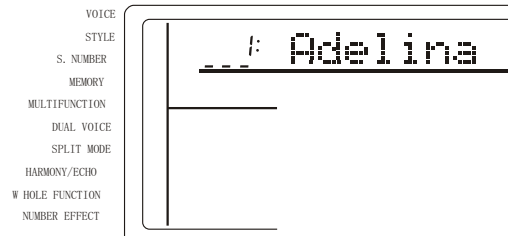

- 5. Quit

Press [DEMO] or [PLAY/STOP] button to stop the playback, then press [VOICE] button to remove the function back to normal performance.

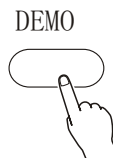

NOTICE:

If you press the [PLAY/STOP] button again after you stopped the playing all the demo songs in order, this instrument only plays the present demo song and stops when the song stops.

BASIC OPERATION

This instrument can display many important parameters in the screen. The following are the introductions about these parameters and icons in the screen, and as well as the basic operation of the panel buttons.

Cursor Buttons

These buttons are used to select various parameters in the screen. The selected parameter will either be added an underline, be brightened, or flicker. The cursor will be moved in the direction according to the corresponding cursor button. Up and down cursor buttons can also be applied to select certain functions in the Function Team.

Function Team

By using Up and Down Function buttons you can select every function of this instrument, such as voice, style, song number and etc. The arrow in the screen points to the function you have selected. Pressing the Function buttons to move this arrow

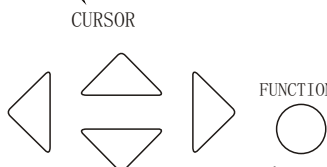

Parameter Icons

BEAT ● ● ● ● Beat Icon
This shows the current tempo and beat both in Song Mode and Style Mode.

REG IST FREEZE Registration Memory Icon
This shows the current setting number of registration memory.

TEMPO Tempo Icon
This shows the tempo of the accompaniment and song playback.

VOICE
STYLE
S. NUMBER
MEMORY
MULTIFUNCTION
DUAL VOICE
SPLIT MODE
HARMONY/ECHO
WHOLE FUNCTION
NUMBER EFFECT

01: Grand

REGIST FREEZE TEMPO 118 TRANS

RHYTHM BASS CHORD PAD PHRASE

ON/OFF

VOICE 1 35 02 17 30

VOL

Accompaniment Track Parameters and Icons.

There are altogether 7 accompaniment tracks, such as Rhythm, Bass, Chord 1/2, Pad and Phrase 1/2. Each track has its own switch, voice number and volume parameter. When one track is turned on, the corresponding icon appears in the screen.

RHYTHM BASS CHORD PAD PHRASE



Transpose Icon
This shows the value of current transpose.



Measure Icon
This shows the measure number of current song playback.



Repeat Icon
This tells you the Points A and Point B when you editing the repeat section.



Chord Icon
This tells you the current chord name in both Song Mode and Style Mode.

Mode

In the right part of the panel, there write four modes of this instrument. You can select each one by pressing [MODE] button. The arrow next to the modes points to the mode you current use.

Normal Performance. Normal Performance Mode

Keyboard Split The keyboard has been divided into two parts, which can be applied to two different voices.

Single Finger Chord Single finger accompaniment. Press one, two or three keys to decide the chord.

Fingered Chord Fingered accompaniment. The chord is played according to the exact chord you've played.

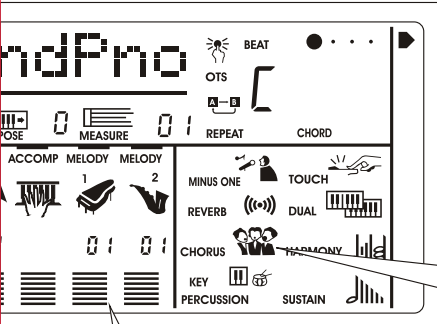

N. PERFORMANCE
KB SPLIT
S.FINGER
FINGERED

Function ON/OFF Icons

MINUS ONE Minus One. It appears when this function is selected.

REVERB Reverb. It appears when Reverb Function is turned on.

CHORUS Chorus. It appears when Chorus Function is turned on.

TOUCH Touch. When this icon appears, the keyboard enables the Touch Response function.

DUAL Dual. It appears when Dual Function is turned on.

HARMONY Harmony. It appears when Harmony/Echo Function is turned on.

SUSTAIN Sustain. It appears when Sustain Function is turned on.

PERCUSSION Keyboard Percussion. It appears when the keyboard percussion is turned on.

Song Track Parameter and Icons

These three Song Tracks also can have switches, voice numbers and volume parameters just like the accompaniment tracks. Corresponding icon appears in the screen when the tracks is turned on.



PLAYING THE PIANO

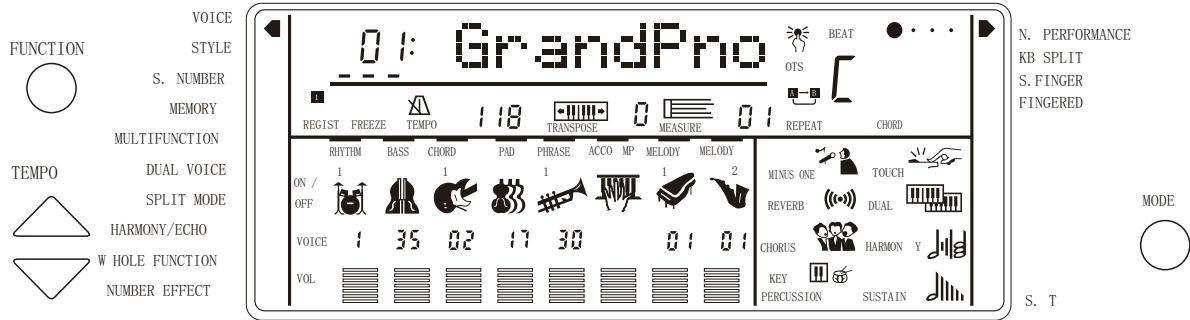

Selecting and Playing a Voice

This instrument comes with 153 built-in voices and 10 percussion items. Use the following procedure to select the voice you want to use.

1. Selecting the normal mode

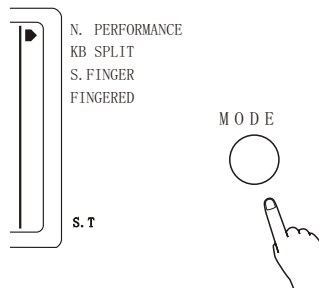

Under this mode, the instrument can only perform a single voice. Press the [MODE] button in the panel until the arrow in the screen points to the normal performance position.

2. Selecting the Voice Play function

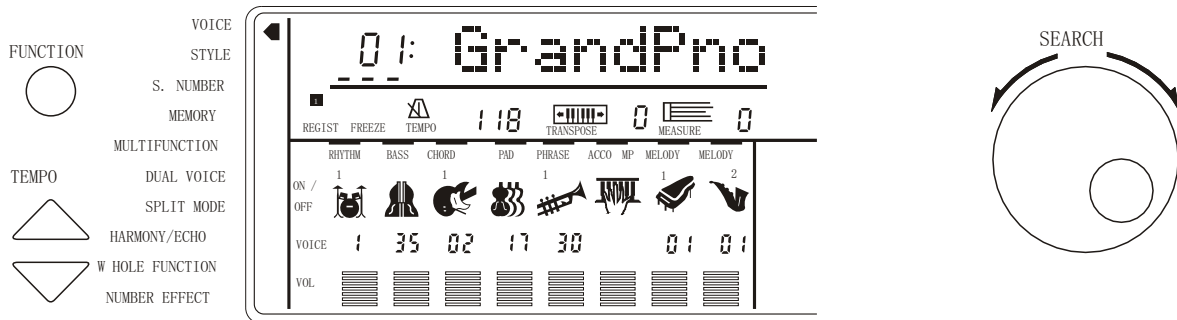

You have to select the Voice Play Function before performance. First press [FUNCTION] button until the arrow points to the [VOICE] position, then adjust [SEARCH] dial to select the voice you desire or select directly one of 32 common voices from the [VOICE] team. When the up-light of the [VOICE] button is on, it indicates the voice you can select is among the down-row voices; otherwise, it is from the up-row voices.

■ 3. Selecting a Voice

You can adjust the [SEARCH] dial to select one voice from the total 153 voices. The voice list has been listed on the panel, and the present voice name and number shows in the first line of the screen.

[SEARCH] dial

During the Voice Play function, this dial can change the voice number in order

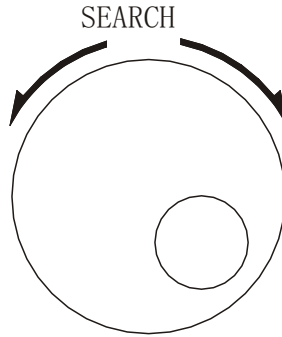

■ 4. Adjusting the Volume

First try the keyboard and then adjust the volume to a suitable place.



NOTICE

In the Whole Function team, the keyboard volume and the accompaniment volume can be separately adjusted. Holding down the [VOICE] button can quickly select the keyboard volume function. More information please refer to P. 46.

PERCUSSION

Press [PERCUSSION] button to turn on / off keyboard percussion voice. In keyboard percussion mode, you can play drum or other percussion on the keyboard. More information please refer to page 53.

• 1. Selecting the PERCUSSION FUNCTION

Keep pressing the FUNCTION button until the "arrow" points to Whole Function position. Then adjust the CURSOR   until the "KbdPERC" appears on the screen.

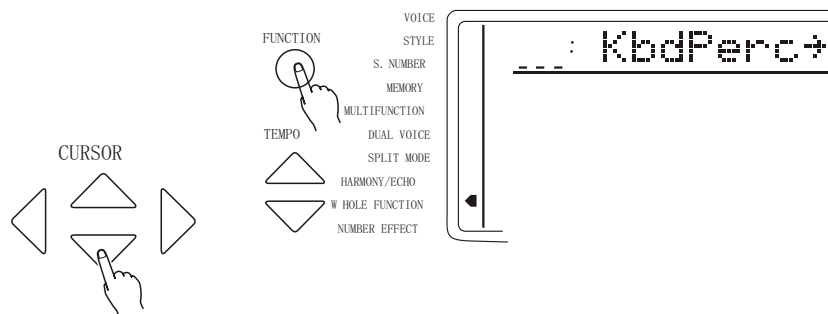

• 2. Selecting the PERCUSSION TEAM

Press the CURSOR button to enter in. Use [SEARCH] dial to select one group of the total 10 Percussion groups. The name of the one you select appears on the screen. You may also hold down the [PERCUSSION] button till the "arrow" in the screen points to the Whole Function position, and the name of present percussion group appears in the screen.

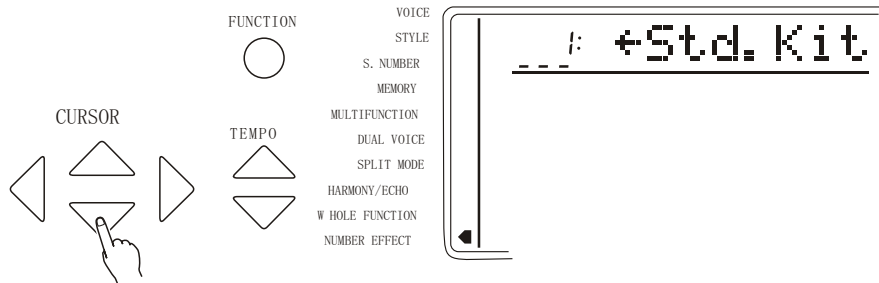

• 3. Percussion team

01	STANDARD DRUMS	02	CHINESE PERCUSSION GROUPS
03	ROOM DRUMS	04	ROCK DRUMS
05	ELECTRIC DRUMS	06	T808 DRUMS
07	JAZZ DRUMS (same as 01)	08	BRUSH KIT
09	CLASSIC DRUMS	10	SFX KIT

Notice:

*.while selecting the Percussion, you may not use the DUAL and the HARMONY function at the same time. These functions will automatically lose.

KEYBOARD SPLIT MODE

*.Under this mode, the keyboard splits to the right & left hands. Each can play a different voice.

Example: BASS/PIANO

This mode splits the keyboard. One range is assigned a bass voice and another range is assigned a piano voice. The split point is B3 (Key No. 59). It could be changed willfully. The voice of the right hand selects by normal mode, the voice of the left hand selects by the split mode. The following describes the details.

Press the [MODE] button till the "arrow" marks to the Keyboard Split. Thus you enter into the SPLIT MODE.

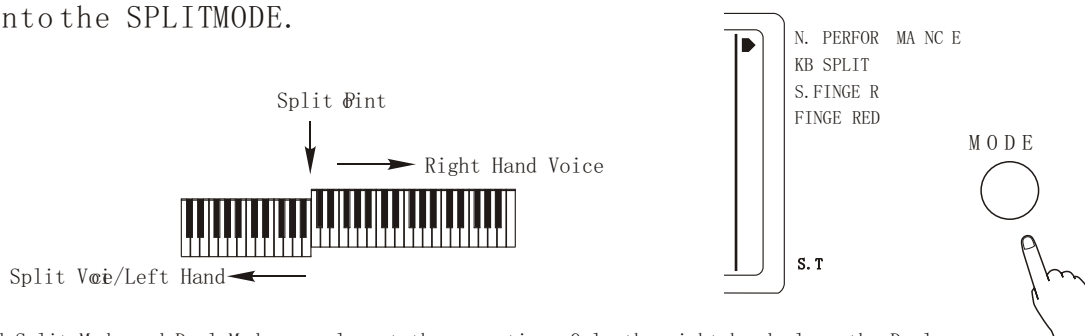

NOTICE

The keyboard Split Mode and Dual Mode can play at the same time. Only the right hand plays the Dual.

Changing the Split voice & relative parameters

1. Selecting the SPLIT MODE

Press the [FUNCTION] button till the "arrow" marks to the SPLIT MODE position

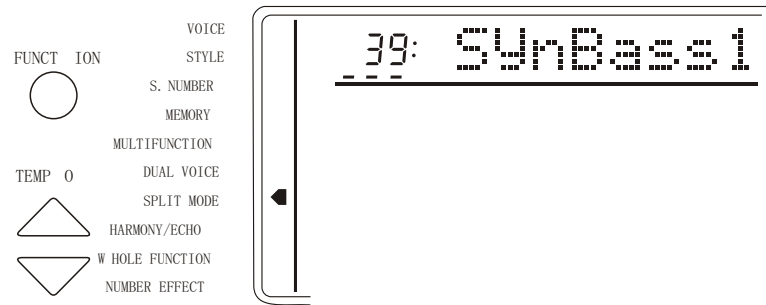

• 2. Selecting the proper function

Press the CURSOR (▲▼) to select the function you want. Then use the [SEARCH] dial to select the parameter setting. The current settings show in the first line of the screen.

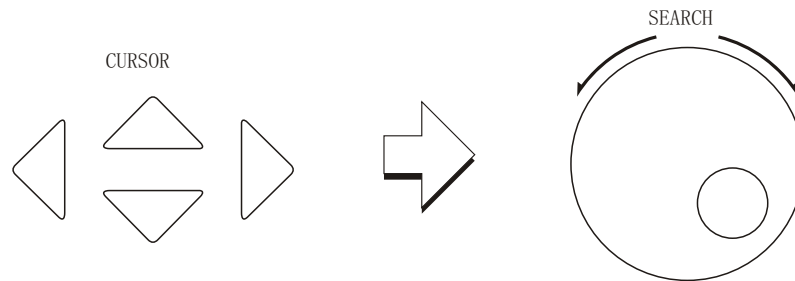

Function	Explanation
Split voice	Change the tone of the left hand
S. Volume	Setting the tone of the left hand (0-127)
S. Octave	Change the volume of the left hand tone. -1: -10 octave -2: -20 octave +1, +2: +1, 2 octave
S. Revlv 1	Setting the tone of left hand output Rev level. From 0 (none) to 127 (Max Effect)
S. Cholv 1	Setting the tone of left hand output Cho level. From 0 (none) to 127 (Max Effect)
S. Pan	Setting the pan of left hand tone. From -7 (left) to +7 (right)
S. Split	Setting the split point. The point itself belongs to the left hand. Directly press one key to set the point and parameter appears on the screen. Or you can also use the CURSOR (▲▼) or the number button to select the key number. C1=36, centre C (C3)=60, C6=96. Split point could be any key from 0-127. (if set for MIDI, original point set as 59 (B2)).

NOTICE:

Pressing TEMPO + & - together can enable the initial setting of left hand voice parameter. To enter in minus numbers of S. Pan and S. Octave, you first press Tempo -- button, then press the number. The return level of Reverb and Chorus can be set in Number Effect function.

TOUCH RESPONSE

*. Press the [TOUCH] button may open/close the keyboard touch function. While this function is on, the relative icon appears on the screen display. While the function is closed, the keyboard will produce the same volume to simulate instruments without such touch response, such as the CLASSIC ORGAN & PIANO.

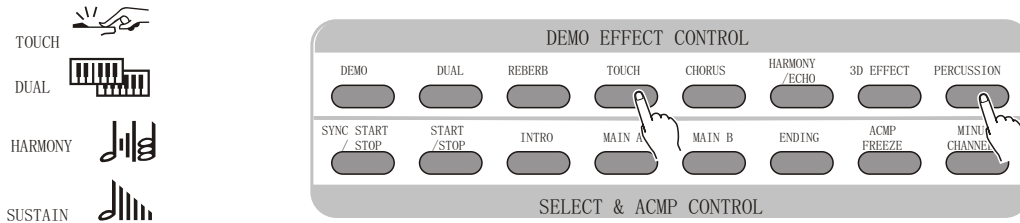

*. This function automatically opens when the power switch turns on. Press the [TOUCH] button to quickly select the parameter of the touch sensitivity. More information please refer to P48.

DUAL VOICE

*This function makes available the keyboard play two combined voices at the same time. One voice is selected by the normal function, and another voice by this function. While the function is selected, the relative icon appears on the screen display.

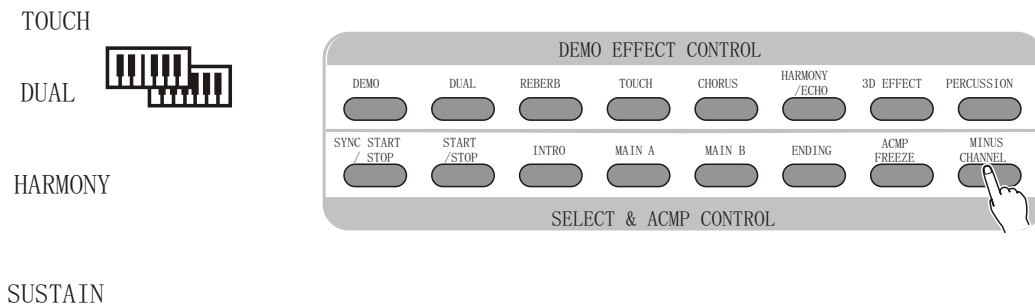

Selecting the relative parameters of DUAL

1. Selecting the DUAL MODE

- Press the FUNCTION buttons till the "arrow" points to the DUAL Mode position.

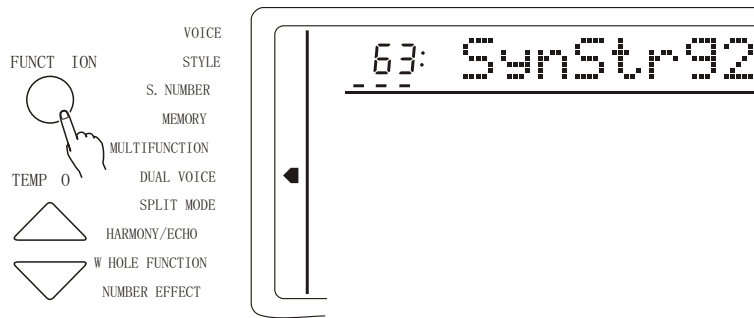

NOTICE

Holding down the [DUAL] button can quickly select the Dual Mode.

2. Selecting/setting the function

- Select the function by the CURSOR button (▲▼). Then use the CURSOR (◀▶) button or numeric buttons to select the parameter setting. The current setting appears in the screen.

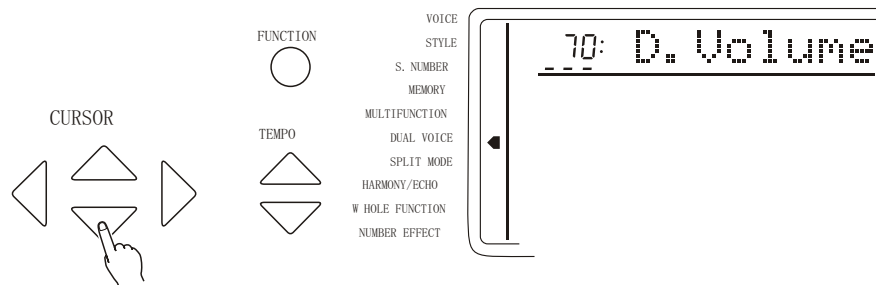

Function	Explanation
Dual voice	To select the second Voice, Its parameter appears in the display This keyboard
D. Volume	Setting the volume of the voice (0-127)
D. Octave	Change the volume of the second octave Voice. -1:-1 Octave -2: 0: octave +1,+2: +1,2 Octave. The original setting by the Function team.
D. Revlv1	Setting the second voice of the dual output Rev-level. From 0 (none) to 127 (Max Effect)
D. Cholvl	Setting the second voice of the dual output Chorus-level. From 0 (none) to 127 (Max Effect)
D. Pan	Setting the pan of the dual. From -7 (left) to +7 (right)

NOTICE

Percussion can not be applied to Dual.

Pressing TEMP + & - at the same time can remove the second voice parameter to its initial setting.

The Octave pitch of the Main is changed in the Whole Function.

To enter minus number of the D. Pan and D. Octave, first hold down the CURSOR button then press the number

The return levels of Reverb and Chorus are set in the Number Effect function.

3. Quit

Press the [VOICE] button or select the other function to quit from this mode.

HARMONY/ECHO

Harmony Effect (01, 02) can add appropriate harmony notes to your melody depends on the chord played by your left hand.

Echo Effect (03--10) can add sustain effect to your right hand performance.

Press [HARMONY/ECHO] button to open / close this function. When this function is selected, relative icon appears in the screen.

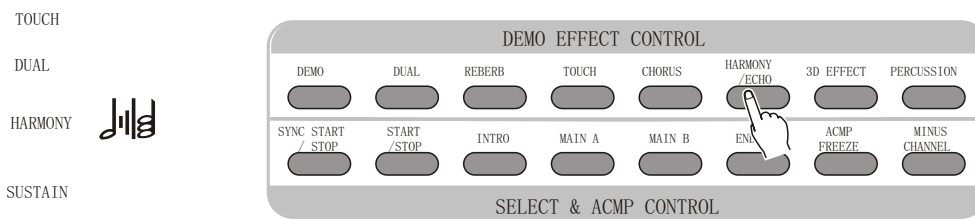

NOTICE

When the percussion is selected, Harmony / Echo function can not be used at the same time.

Under Normal Performance mode, Harmony function can not be used.

Harmony function can be applied to Single Finger and Fingered Accompaniment Mode.

Selecting the Harmony / Echo

1. Selecting the Harmony / Echo

- Press the [FUNCTION] button till the "arrow" points to the Harmony / Echo position.

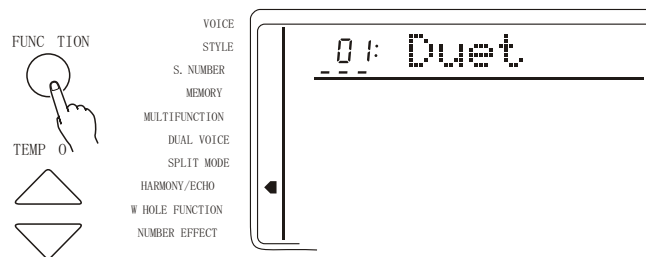

Holding down the [HARMONY/ECHO] button can quickly select the Harmony / Echo function.

2. Selecting the type of Harmony / Echo function

Adjust the [SEARCH] dial to select.

NOTICE

Press the CURSOR



buttons together to return to the initial setting of Harmony / Echo function type.

TYPE	EXPLANATION	
01:Duet	Double-voice Harmony, 2nd voice lower than the melody	
02:Octave	Add a bass octave to the melody	
03:Tremolo 1/4	Produce the tremolo 1 / 4	
04:Tremolo 1/6	Produce the tremolo 1 / 6	
05:Tremolo 1/8	Produce the tremolo 1 / 8	
06:Tremolo 1/12	Produce the tremolo 1 / 12	
07:Echo 1/4	Produce the Echo 1 / 4	
08:Echo 1/6	Produce the Echo 1 / 6	
09:Echo 1/8	Produce the Echo 1 / 8	
10:Echo 1/12	Produce the Echo 1 / 12	

3. Quit

Press [VOICE] button or to select another Function to quit.

SUSTAIN

Sustain Pedal: Using this pedal can bring sustain effect to the melody

SOSTENUTO

Sostenuto Peda : Using this pedal ~~sustain~~ sustain one note or one chord and meanwhile having no effect on other notes.

SOFT

Soft Pedal: Using this pedal can diminish the sound of the melody.

NOTICE:

We have two versions of W8812B. In economy version, there is no pedal, however in deluxe version, all the pedals stated above will be there.

TRANSCOPE



*.This function makes the keyboard transpose a half tone.

- 1. TO SELECT THE PARAMETER OF THE TRANSCOPE



Use the CURSOR buttons to select the number at right side of the “TRANSCOPE” in the screen display which makes the number flash.

NOTICE:

- *. Press the CURSOR   buttons at the same time can remove the transpose parameter to 0. The new parameter of the transpose will act on the following tone.

2. To set the parameter you need

- Use the [SEARCH] dial to select the parameter number (-12 to +12). 0 stands for the standard pitch

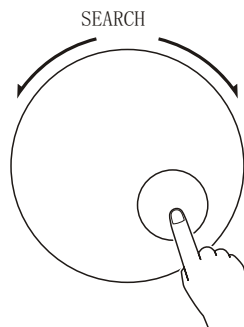

NOTICE:

- *. Press the CURSOR  and the number button at the same time to enter in minus number.

NUMBER EFFECT

USING NUMBER EFFECT

This instrument provides many Number Effects: 8 Reverbs; 8 Chorus; 3 D Effect to make your play perfect.

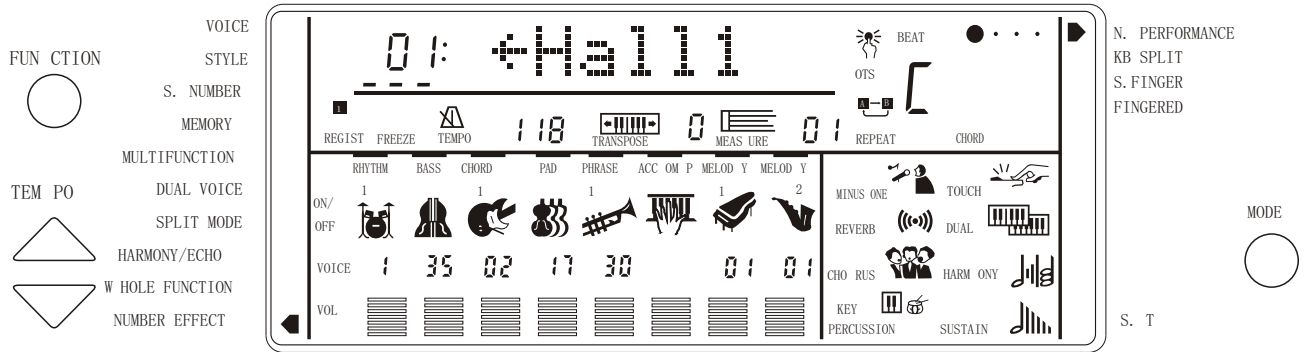

The Number Effects are : Reverb, Chorus, 3D Effect

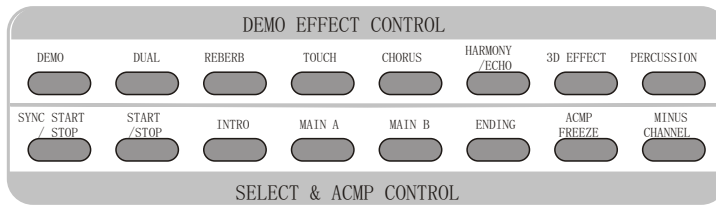

CHANGING THE REVERB EFFECT

Selecting the Reverb Style

- 1. Selecting the Reverb function

Press the FUNCTION button till "arrow" points to the NUMBER EFFECT position. Then select the REVERB by the CURSOR (up/down) buttons.

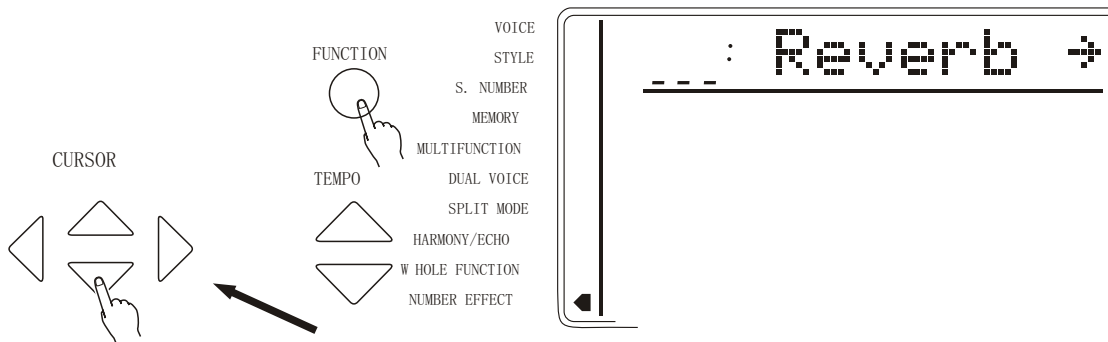

- 2. Selecting the Reverb type

Use the  CURSOR to enter in Then adjust the [SEARCH] dial to select one of the 8 Reverbs. The relative name appears in the screen. Also you can press [REVERB] button until the arrow in the screen points to the Number Effect position.

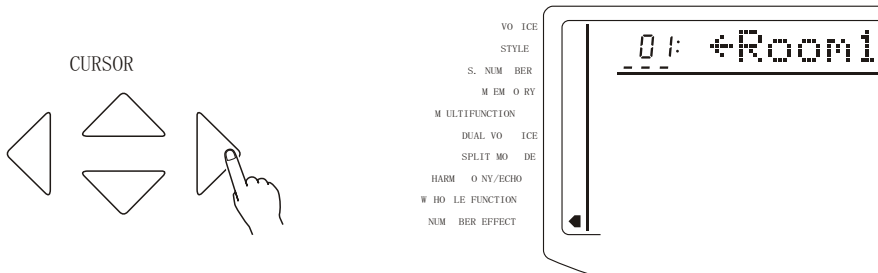

- 3. Quit

Press [VOICE] button or select another function to quit.

Notice:

Pressing both CURSOR  buttons returns to the original Reverb setting.

Press the CURSOR  to return to the former page, 'Reverb' and then select the Chorus type.

ype: Reverb T

01:ROOM1	02:ROOM2
03:ROOM3	04:HALL1
05:HALL2	06:PLATE
07:DELAY	08:PANNING DELAY

Setting Reverb Return Level

This parameter determines the output of the Reverb Effect

- 1. Selecting the Reverb Return Level

Press the FUNCTION button till the "arrow" points to the NUMBER EFFECT position. Then select the RevRtnLv by the CURSOR  buttons.



Notice:

This setting influences all the voices. Every voice of the reverb send level (including Split & Dual) could be set separately.

Press both CURSOR  buttons may return to the original setting of Reverb return level (64).

- 2. Setting Return Level

Use the [SEARCH] dial to adjust.

- 3. Quit

Press the [VOICE] button or select another function to quit.

CHANGING THE CHORUS

Selecting the Chorus Style

- 1. Selecting the Chorus Function

Press the FUNCTION button till the "arrow" points to the NUMBER EFFECT position. Then select the Chorus by the CURSOR  buttons.

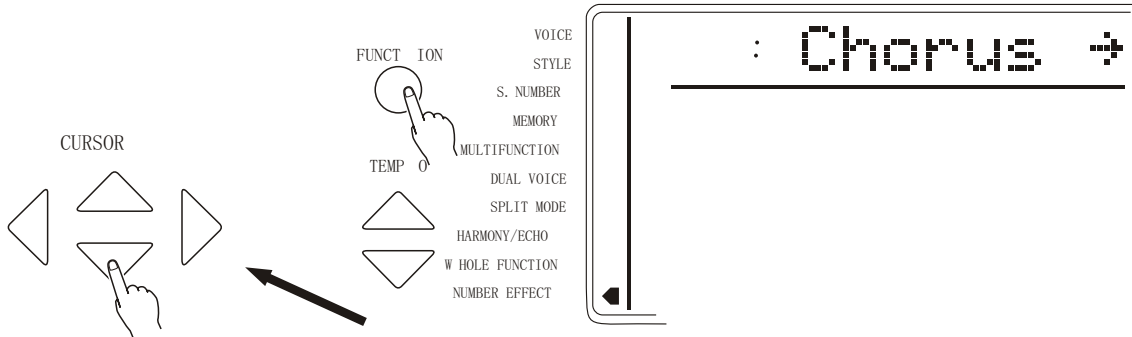

- 2. Selecting the Chorus style

Use the  CURSOR to enter in. Then adjust the [SEARCH] dial to select one of the 8 Chorus. The relative name appears on the display.

You may also press the [CHORUS] button till the "arrow" points to the NUMBER EFFECT position, and the current chorus name appears in the first line of the screen.

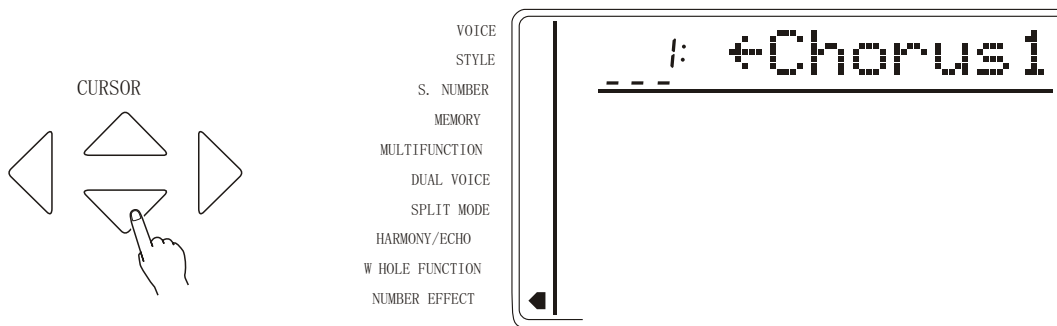

- 3. Quit

Press the [VOICE] button or select another function to quit.

Notice:

Pressing both CURSOR  buttons may return to the original setting of Chorus style.

Press the CURSOR  to return to the former page: 'Chorus' and then select the Reverb style:

CHORUS STYLE

01: CHORUS1	: CHORUS1
03: CHORUS3	: CHORUS3
05: FEEDBACK CHORUS	06: FLANGER
07: SHORT DELAY	: SHORT DELAY WITH FEED-BACK

Setting the chorus Return level

This parameter determines the output level of chorus Effect.

- 1. Selecting the Chorus Return Level

Press the [FUNCTION] button till the "Arrow" points to the NUMBER EFFECT position. Then select the ChoRtnLv by the CURSOR   buttons.



- 2. Setting the Return Level



Use the [SEARCH] dial to adjust. (00-127)

- 3. Quit

Press the [VOICE] button or select another function to quit.

Notice:

This setting influences all voices. Each reverb send Level of the voice (including Split & Dual) could be set separately

Pressing both CURSOR   buttons may return to the original setting of Reverb return level. (64).

3 D EFFECT

*. Press the [3D EFFECT] button and the "arrow" points to the 3D EFFECT position of the WHOLE FUNCTION. Then you can open / close 3D EFFECT by pressing TEMPO + & -.

USING AUTO ACCOMPANIMENT

This instrument comes with 100 built-in styles.

*. The following procedure describes how to use the keyboard's Auto accompaniment feature.

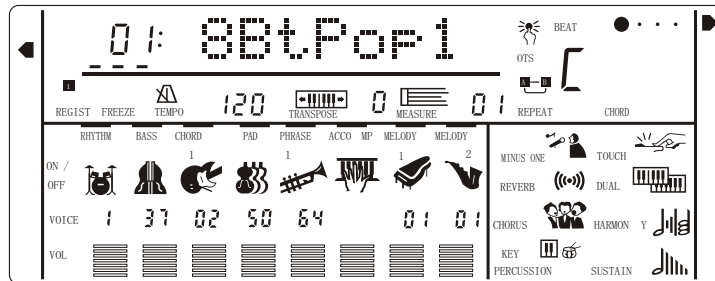

1. Selecting Accompaniment Mode

Keep pressing the [MODE] button (on the right side of the panel) until the "arrow" points to the SINGER FINGER or FINGERED MODE.

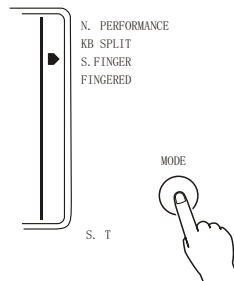

*. SINGER FINGER MODE

Under this mode, the chord accompaniment lets you play four types of chords with one or two fingers..

Example

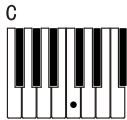

Major

Chord Types

Major chord—Press the root note of the chord.

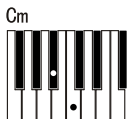

Minor

Minor chord—Press the root note together with the nearest black key to the left of.

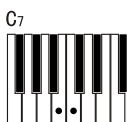

Seventh

Seventh chord—Press the root note together with the nearest white key to the left of.

Cm7



minor seventh

Minor seventh chord--Press the root note together with the nearest white and black keys to the left of it (three keys altogether).

*. FINGERED MODE

Under this mode, the left keyboard (In Style mode, the split point always lays at key. 54) plays the accompaniment chord. The following chords listed are recognizable (C chords for example, notes in parentheses can be omitted)



				CHORD NAME	ABBREVIATION	
				MAJOR	M	1-3-5
				MAJOR SIXTH	M6	1-3-5-6
				MAJOR SEVENTH	M7	1-3-(5)-7
				MAJOR SEVENTH		
				SHARP ELEVENTH	M7#11	1-(2)3#4-(5)-7
				MAJOR ADD NINTH	Madd9	1-2-3-5
				MAJOR NINTH	M9	1-2-3-(5)-7
				MAJOR SIXTH ADD NINTH	69	1-2-3-(5)-6
				AUGMENTED	aug	1-3-#5
				MINOR	m	1b3-5
				MINOR SIXTH	m6	1b3-5-6
				MINOR SEVENTH	m7	1-b3-(5)-7
				MINOR SEVENTH		
				FLATTED FIFTH	m7b5	1-3-5-7
				MINOR ADD NINTH	madd9	1-2-3-5
				MINOR ADD NINTH	m9	1-2-3-5
				MINOR MAJOR ELEVENTH	m11	1-3-(5)-7
				MINOR MAJOR NINTH	mM9	1-2-3-(5)-7
				DIMINISHED	dim	1-3-5
				DIMINISHED SEVENTH	dim7	1-3-5-6
				SEVENTH	7	1-3(5)-7
				SEVENTH SUSPEND FOURTH	7sus4	1-4-5-7
				SEVENTH NINTH	79	1-2-3-(5)-7
				SEVENTH SHARP ELEVENTH	7#11	1-(2)3-#4-(5)-b7
				SEVENTH THIRTEENTH	713	1-3-(5)-7
						或2-3-5-6-7
				SEVENTH FLATTED NINTH	7b9	1-2-3-(5)-7
				SEVENTH FLATTED		
				THIRTEENTH	7b13	1-3-5-6-7
				SEVENTH SHARP NINTH	7#9	(1)-#2-3-(5)-7
				MAJOR SEVENTH		
				AUGMENTED	M7aug	1-3#-5-7
				SEVENTH AUGMENTED	7aug	(1)-3-#5-7
				SUSPEND FOURTH	sus4	1-4-5
				ONE PLUS TWO PLUS FIVE	1+2+5	1-2-5

NOTE:

- Notes in parentheses can be omitted.
- Playing two same root keys in the adjacent octaves produces accompaniment based only on the root.
- A perfect fifth (1+5) produces accompaniment based only on the root and fifth which can be used with both major and minor chords.
- The chord fingerings listed are all "root" position, but other inversions can be used with the following exceptions: 5m7b5, m7b6, sus4, aug, dim7, 7b5, 6(9), 1+2+5.
- Inversion of the 7sus4 and m7(11) chords are not recognized if the notes shown in parentheses are omitted.
- The auto accompaniment will sometimes not change when related chords are played in sequence (e.g. some minor chords followed by the minor seventh).
- Two-note fingerings will produce a chord based on the previously played chord.

■ 2. Selecting the STYLE Function

Press the [FUNCTION] button till the "arrow" points to the STYLE position.

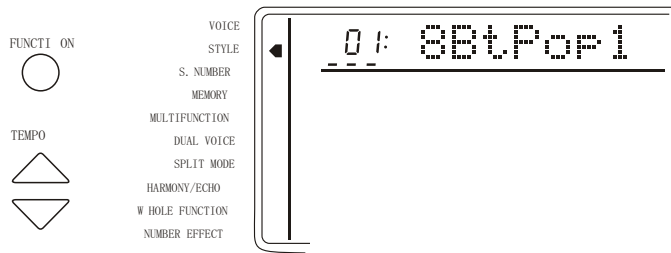

*. Keep pressing the [STYLE] button to quickly select the ACCOMP VOL parameter in the whole function.
[Refer to P 47]

■ 3. Selecting a STYLE

*. Use the [SEARCH] dial to select one of 100 style of this instrument. More information please refer to P 54.

On the front panel there are 32 commonly-used accompaniment styles.

The current style and number show in the screen.

*. While [A/B] up-light on, the voice you select is the down side, while the down-light the up side style.

■ 4. Setting the TEMPO

Every Style type has its own Tempo. It displays on the right side of the TEMPO mark. While the Accompaniment is started, this tempo will not be changed even if you select any other style at the same time.

To select the tempo of 40-240/tempi by the TEMPO ▲▼ buttons. Every press to increase one tempi. Keep pressing to quicken the procedure. Press the TEMP ▲▼ at the same time to return to the original tempo.



You may also select the tempo parameter by the CURSOR buttons. Use the CURSOR ◀▶ buttons and the NUMBER buttons to change the parameter. Press the CURSOR ◀▶ buttons at the same time to return to the original tempo. You can select this while during or before the performance.

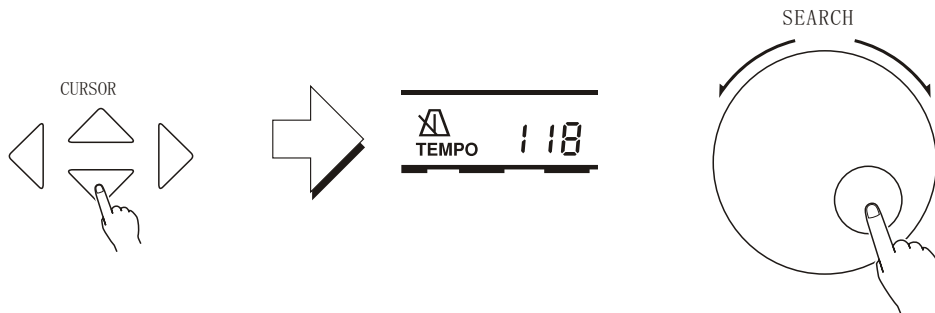

■ 5 Start the Accompaniment

*. Direct start:

Press the [START/STOP] button, rhythm will start playing the current choice A or B without Bass and chord.

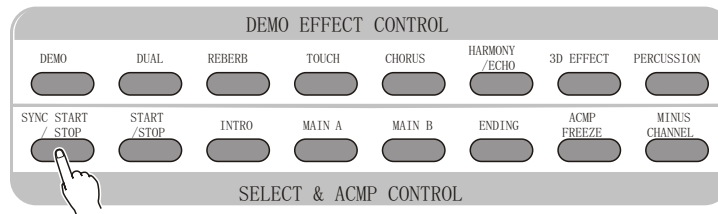

*. Started from Intro, and then play the Main [A]

Press the [INTRO] button, and then press the [A] to make the light on. (If the light is already on, then you do not have to press this button.)

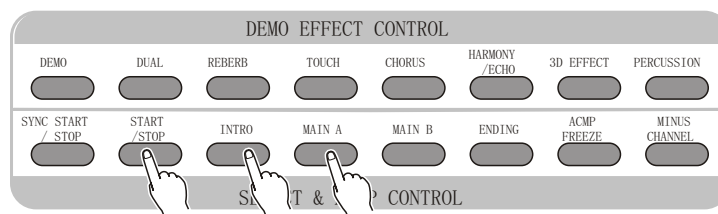

*. Started from Intro, and then play the Main [B]

Press the [INTRO] button, and then press the [B] to make the light on. (If the light is already on, then you do not have to press this button.)

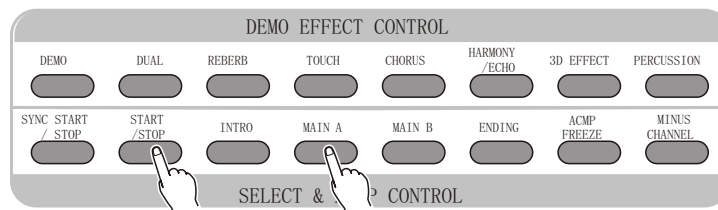

*. SYNC Start

Press the [SYNC/STOP] button to enable you to play any style of the accompaniment while you first press the Split Point in the left keyboard. 54(F#3).

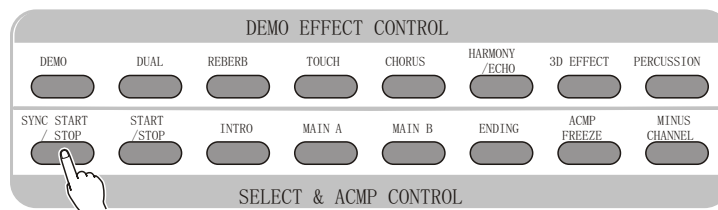

Pressing the [SYNC/STOP] button only makes the accompaniment play after you first press a key on the left hand of the keyboard. Pressing the [SYNC/STOP] button first and then press the [INTRO] & [MAIN] buttons enables you to have the Sync with intro. While selecting the Sync style, tempo light flashes and shows the current tempo. Pressing the [SYNC/STOP] button again before playing will cancel this function.

Notice:

*. While playing, you may also select the [INTRO] button to play Intro.

*. Press the [SYNC/STOP] button to stop the accompaniment and enter into the Syncro.

*. The Split Point setting could be changed by the Whole Function.

■ 6. Using Auto Accompaniment

This instrument will automatically recognize the chord while you are playing the left part, and it can play the proper bass chord for the current style. Even if your left hand has released the keys, it will still automatically continue playing. The name of the chord displays in the screen.

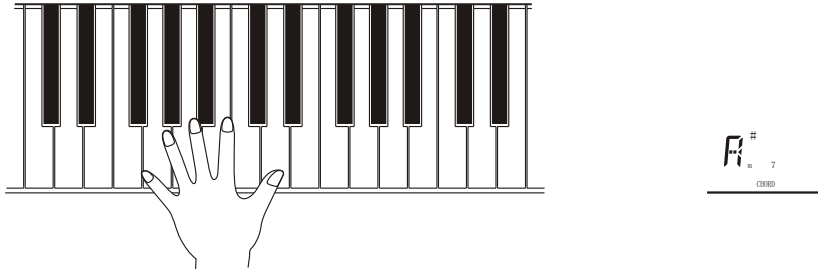

*. BEAT display

In the BEAT part shows current Beat.

	4/4 time	3/4 time
1st beat	● ● ● ●	● ● ● ●
2nd beat	● ● ● ●	● ● ● ●
3rd beat	● ● ● ●	● ● ● ●
4th beat	● ● ● ●	BEAT

BEAT

■ 7. To select Main (A) or (B)

While playing, you can freely choose Main [A] or [B]. After you press [A] or [B], this keyboard will automatically add in a kind of fill-in (altogether kinds), in order to make the change smoothly. This is also available for the same part. For example: While you are playing Main [A] and press the Main [A] at the same time, this keyboard will quickly finish, and then continuously play the Main [A]. The same for different Main.

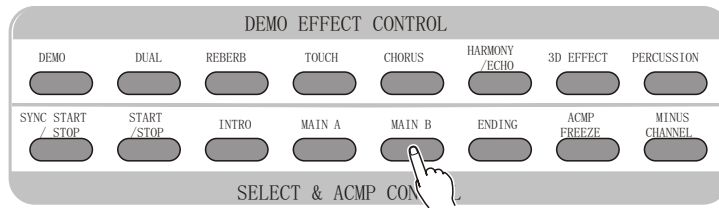

■ 8 Stopping the Auto Accompaniment

Press [START/STOP] button to stop accompaniment. Or press [ENDING] button to stop it after the ending. The Ending will start from the beginning of next measure.

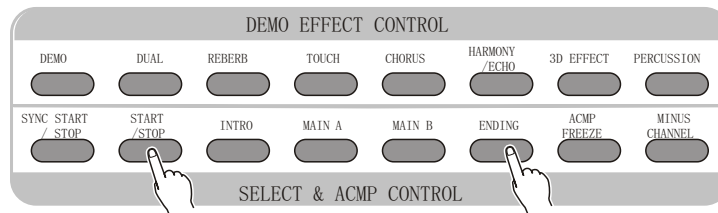

*. The volume of the Accompaniment could be set by the Whole Function. (Refer to B47)

*. Quiescence Accompaniment Function

Under the function of Single Finger & Fingered, after you stop the accompaniment, if you play on the left part of the keyboard, it will continue playing proper bass chord that suitable for your performance.

ACCOMPANIMENT	TRACK CONTROL
---------------	---------------

*. This instrument has 7 Accompaniment Tracks: RHYTHM, BASS, CHORD1/2, PAD and PHRASE1/2. After a style is selected, CHORD1 and PHRASE1 will display in the screen. Press FUNCTION button till the "arrow" points to the track position. Press the CURSOR (◀▶) buttons can select 7 tracks. Then you can use CURSOR (◀▶) buttons to open/close the Accompaniment Track separately.

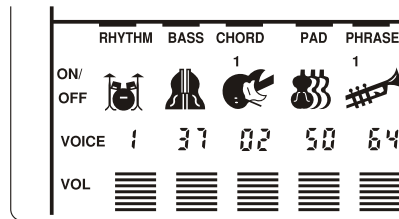

*. The content of Accompaniment Track:

RHYTHM	Provide the Percussion or Drum voice
BASS	Provide different Bass voices, according to the styles, such as ELECTRIC BASS; ACOUSTIC BASS
CHORD 1&2	Provide the Rhythm Strings accompaniment, like the voice of Guitar and Piano.
PAD	Provide the long chord, such as strings and Organ.
PHRASE 1&2	Provide the decorations, including the separate Chord, strong note, etc.

Notice:

While a style is selected, the track including the data will display the screen.

■ Big & Small Accompaniment

This is the simplest way to control the accompaniment track. Using this button can open / close certain accompaniment track. If the Big Accompaniment is selected, all the tracks are open; if the small one, the icons for some tracks disappear.

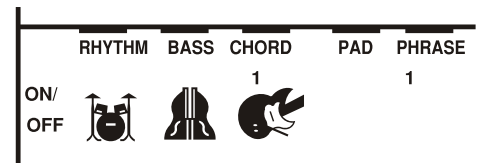
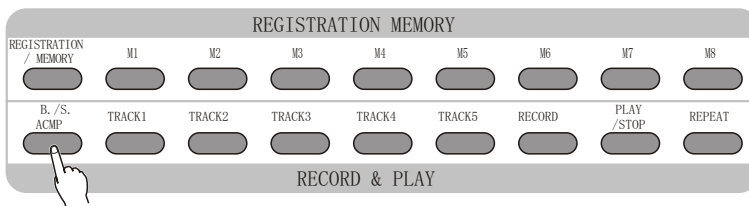

NOTICE

If a new style is selected, the instrument will automatically select the Big Accompaniment mode. The accompaniment selects the tracks according to the style. Sometimes, some tracks are closed, and you are not able to open them.

■ Mute the Accompaniment

This instrument provides you with full control to the accompaniment. Pressing corresponding track number button can open /close (mute) that track. When the track is muted, its icon disappears. For example: Direct pressing PHRASE 1 / 2 track button can close these two tracks.

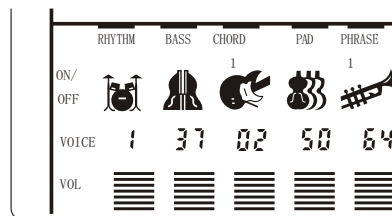
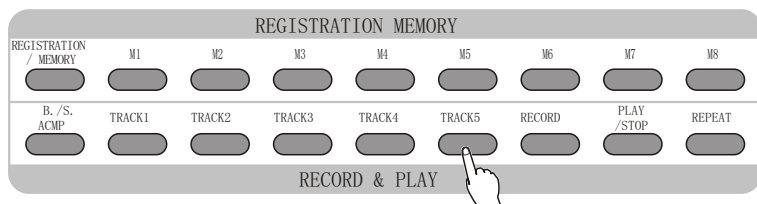

Holding down the track number buttons can fast enter in the track menu. Pressing & - buttons to open / close the tracks. This method can close PHRASE 1, PHRASE 2, CHORD 1, CHORD 2 separately.

■ Changing the Accompaniment Voice

Move the cursor to track voice position, and it flickers. Then use the left and right buttons to select the voice number. The accompaniment uses default voice from what printed on the panel.

RHYTHM track can only use voices from 1 to 8, and other tracks can select from 00 to 152.

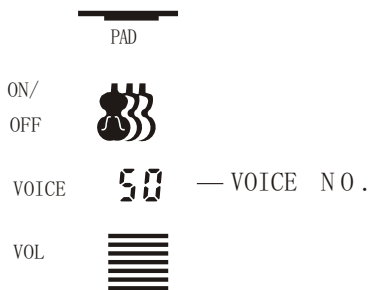

■ Adjusting Accompaniment Volume

Adjusting the volume of each track can produce proper reverb effect. Move the cursor to the track volume position, and it then flickers, then set the value. The bigger the value, the bigger the volume, and it can keep its peak volume.

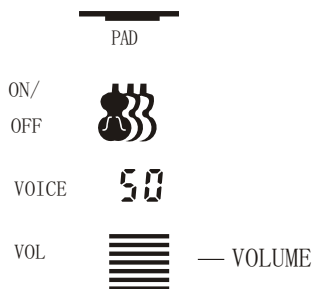

NOTICE

If selecting another style, the accompaniment track parameters will recover. You can use registration memory function to save the parameter setting you need.

After changing the voice or volume, you can press Tempo + & - at the same time to recover the initial setting.

Track data has effect on every section (Intro, Ending, etc). During the song record, a single track is muted, and changing the accompaniment track voice and volume function have no effect.

CHANGING THE SPLIT POINT OF ACCOMP

ANIMENT TRACK

- 1. Selecting the splitpoint function

Press the FUNCTION button on the front panel the "arrow" points to the Whole Function. Then use the CURSOR (▲▼) buttons to select the AccSpPnt.

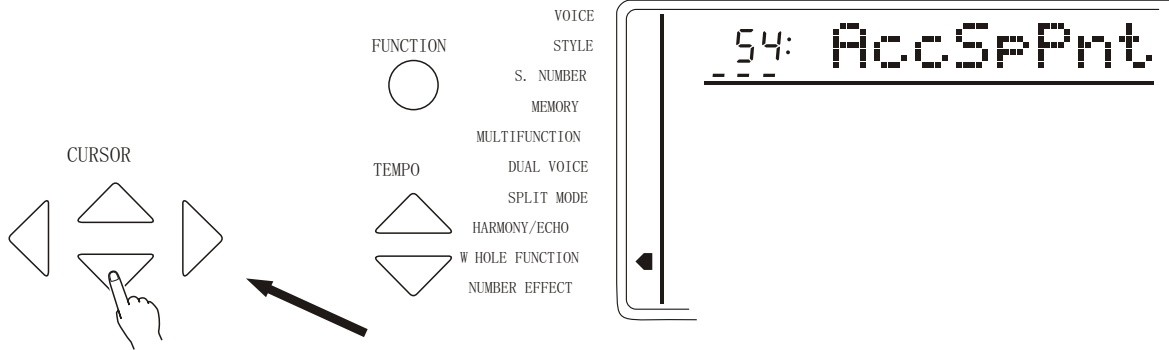

- 2. Setting the Data

Input directly by the Key (of the keyboard). Or select by the [SEARCH] dial. The relative name appears in the screen. The lowest C1 keyboard number is 36; centre C (C3) is 60; and highest C6 is 96. Split point number could be any of 0-127 (though it has overpassed the range of this instrument) in order to make easier using the MIDI Function.

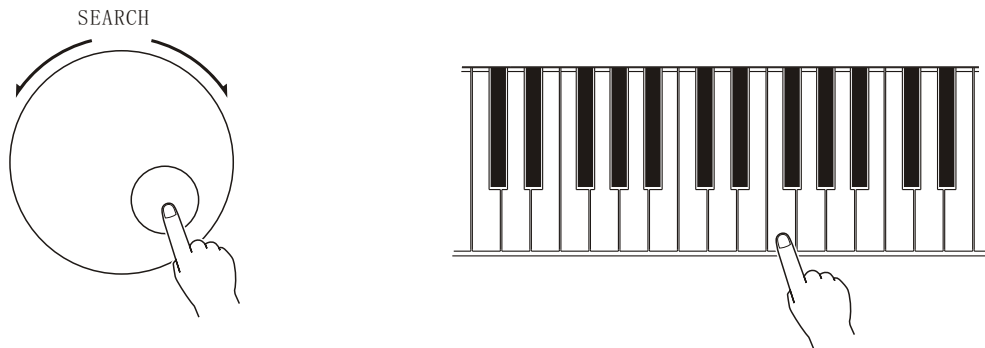

- 3. Quit

Press [VOICE] or select other function to quit.

Notice:

Split point is the highest note of the left handpart.

Press the CURSOR (◀▶) buttons together can return to the original setting 59.

REGISTRATION MEMORY

REGISTER PANEL SETTING

The memory of this instrument can record 8 parameters of panel setting. It could be recalled at your service.

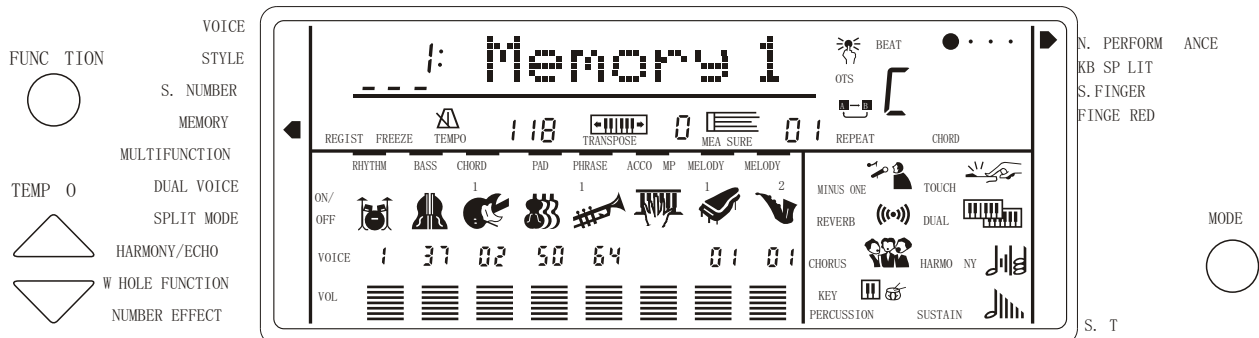

1. Setting the control buttons needed.

The following setting could be saved.

- *. Voice number
- *. Split voice Parameters
- *. Dual parameters
- *. Harmony/Echo type
- *. Volume of the keyboard
- *. Octave
- *. Rev Level
- *. Pan
- *. Touch sense
- *. P. Range
- *. Metronome (on/off)
- *. Percussion team
- *. Effect (on/off)
- *. Chorus Level
- *. Accompaniment Volume
- *. Split Point (Accompaniment function)
- *. Reverb (Reverb RevRtnLv)
- *. Chorus (Chorus ChoRtnLv)
- *. Transpose
- *. Accompaniment (open/close; Vol; Tone)
- *. Mode (Normal; Duel; Fingered; Fingering)

2. Registering the setting

while holding down the Memory button, press a memory number button (M1-M8) to make this keyboard memory a new setting. The former data will be erased.

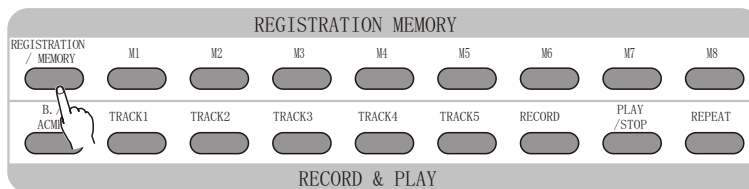

RECALLING THE REGISTERED SETTING

*After select a Memory Bank, press the registration memory number button may recall the corresponding parameter setting. The register number will appear in the screen at the REGIST position. And the parameters will appear in the screen.

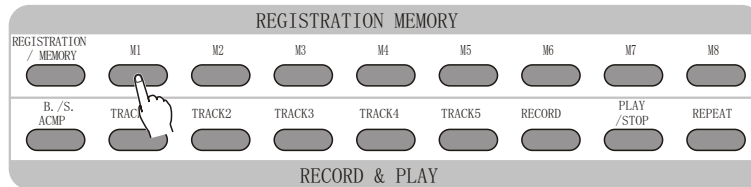

ACCOMPANIMENT FREEZE FUNCTION

* Under this function, recalling a memory number will not change the parameters of the accompaniment. This will not disturb your performance, while using different settings. Press the [FREEZE] button to open/close the function. When this function is on, the word FREEZE appears in the screen.

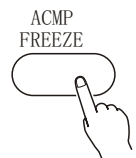
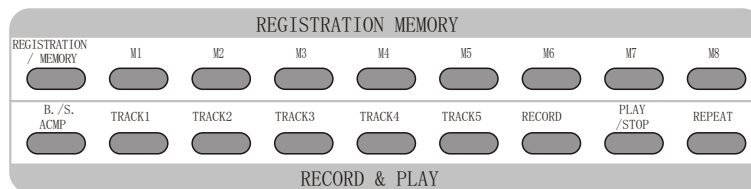

Notice:

Selecting different memory bank will not close the FREEZE function.

SONG RECORDING

*. You can record and replay a song with this instrument that song includes the accompaniment and the melody you played. The song track includes an accompaniment track and two melody tracks Song 5 is a user song (to record your performance). This instrument lets you record a complete user song at one time.

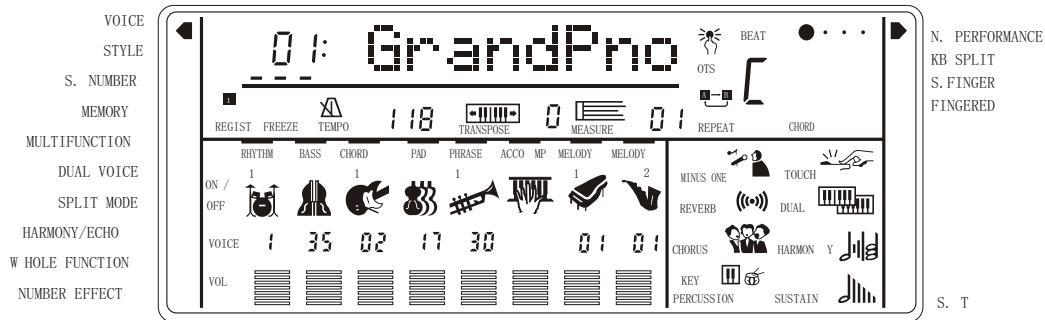

MELODY TRACK RECORDING

Melody Track Recording can control the following operation and data.

- *. Note ON/OFF
 - *. Touch
 - *. Voice number
 - *. Octave
 - *. Vol of the Keyboard
 - *. Tempo (accompaniment and melody track)
 - *. Voice number of the Dual (Vol; Octave; Rev; Chorus Level; Pan) Range
 - *. Rev
 - *. Dual switch
 - *. .B Range
- *. It records only at the beginning of a song. Any changes made during recording will not be recorded.

• 1. Selecting a Song Number

If needed, press the FUNCTION button to select a S. NUMBER. Then use the [SEARCH] dial to select the song.

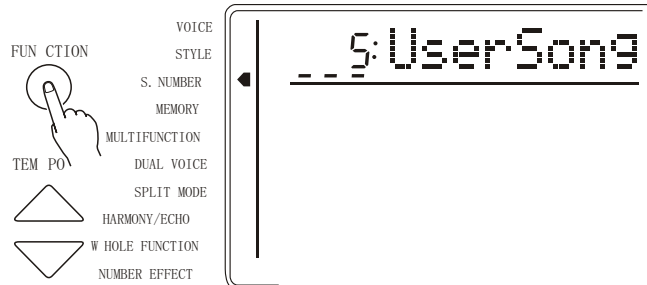

- 2. Selecting the Voice and Setting the relative parameters
After selecting the voice you can set the Effect and other parameters.

Notice:

You can not record in Split Mode. While preparing for recording, keyboard automatically selects the normal mode.

- 3. Entering into the Melody Track Recording Preparation

Press the [RECORD] button, and the light flashes. While REC appears at MELODY 1 position, it shows that it's ready. Use [SEARCH] dial to select another Melody Track.

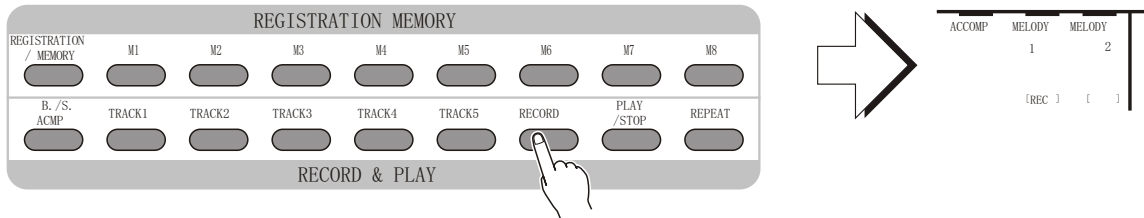

Beat flashing shows the current tempo. If the BEAT function is on, it flashes by the tempo.

Notice:

If the former recorded accompaniment track is on (the relative mark shows on the screen), it could be monitored while recording. If you do not need the accompaniment, press the FUNCTION button to the Song Track position and use the CURSOR (◀▶) to select the Accompaniment track. Use the CURSOR (▶) to close it. Once you press the REC button, this keyboard will automatically select the USER SONG.

The melody track volume is the current volume of the keyboard.

Each time you could only record one Melody track.

Press the REC again to quit the record standby state.

After entering into the record standby, the keyboard will set the measure as 01. (Not from the pointed measure.)

- 4. Recording

Just play the keyboard, press the [PLW/STOP] button to start recording. The indicator shows the current line.

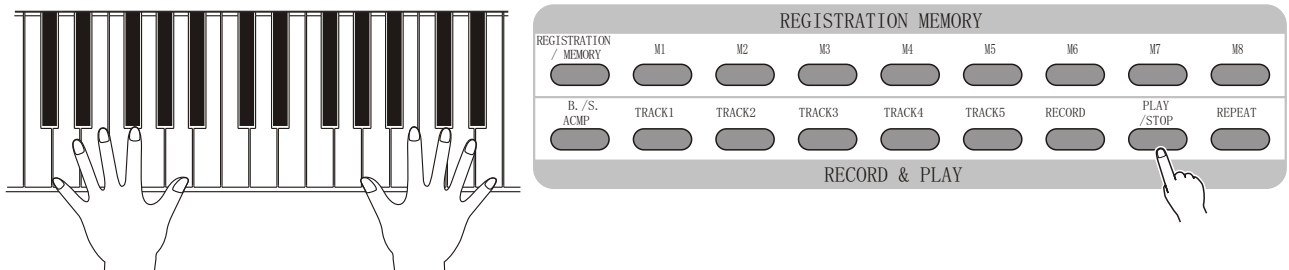

Notice:

Song recording will delete all the former data of the same track.

Recording proceeds by measures. If you stop between the measure, the rest will be recorded as pause.

If the Music Memory is full, the letter FULL will appear on the screen. The recording stops.

Only the Voice number (Voice function) shows in the Melody Track. (No Dual)

• 4. Stop recording

Press the [PLAY/STOP] button, and REC disappears and the volume of the Melody track appears in the screen.

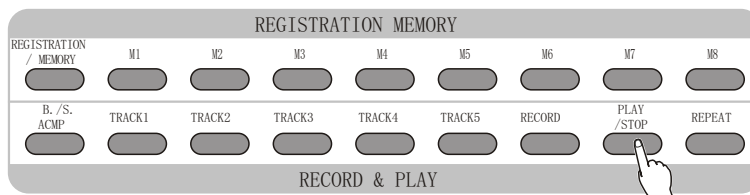

ACMP RECORDING (WITH/WITHOUT MELODY)

Song accompaniment track can record the following data and operation:

- *. Section change (INTRO, FILL IN, ENDING) *. Style number
- *. Chord change, current value Melody track on/off, Voice, Volume change
- *. Rev Accompaniment volume *
- *. Chorus
- * Only start recording when the song begins, and the changes made during the performance will not be recorded.

• 1. Selecting a Song number

If needed, press the FUNCTION button to select the Song number. Then adjust the [SEARCH] dial to select Song Number 5 (USER SONG)

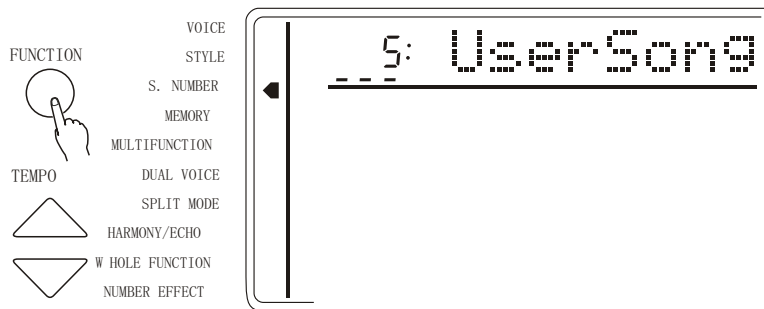

• 2. Selecting Single Finger or Fingered Style

Select Single Finger or Fingered mode and any style to suit the song.

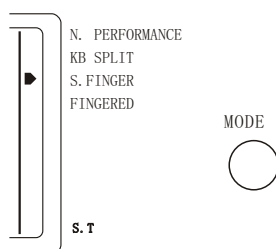

• 3. Entering into ACCMP / Melody Recording Preparation

Press the REC button, and the light flashes "REC" appears at the ACCOMP and MELODY position. Use the [SEARCH] dial to select another melody track. You may also not select any Melody track.

The Time flashes to show current Tempo. If the METRONOME function is on, it flashes by the Tempo.

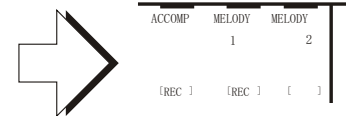
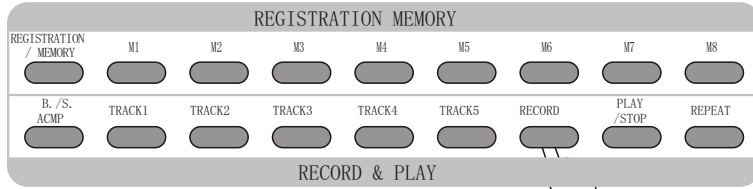

Notice;

If the former recorded Melody track is on (the relative icon shows in the screen), it could be monitored while recording. If you do not need the Melody sound, press the FUNCTION button to the Song Track position and use the CURSOR <> to select the Melody 1, 2. Use the Tempo - to close it.

The volume of the melody is the current accompaniment volume.

After entering into the record standby, the keyboard will set the measure as 01. (It could not start from the pointed measure)

• 4. Recording

At this moment it records the left part of the keyboard you play. If you record both the Accompaniment and the melody, playing at the right part of the keyboard will start recording the melody.

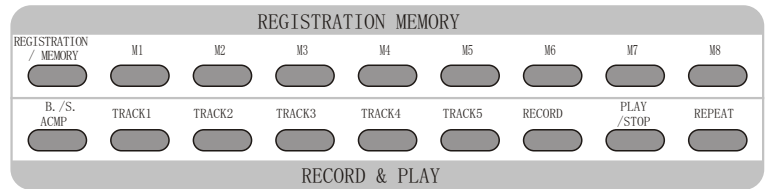
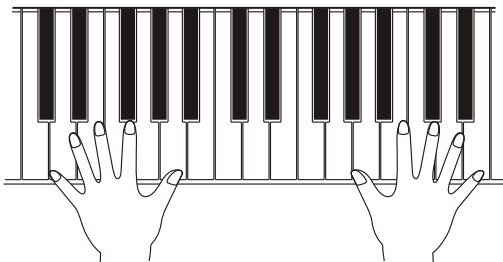

Also you can start recording by press the [START/STOP] button. At this moment there is only Rhythm. Only when you play the accompaniment chord come the Chord and Bass.

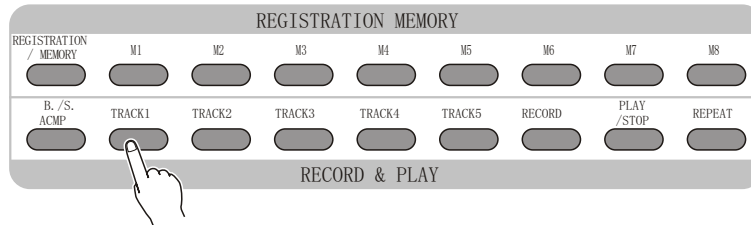

Play every section of the accompaniment (intro main, etc) If you'd like to record both Accompaniment and Melody, playing at the right part of the keyboard will record the Melody.



Notice:

Song recording will delete all former data of the same track.

Recording proceeds by measures. If you stop between the measure, the rest will be recorded as pause.

If the memory is full, the letter FULL will appear on the screen. The recording stops.

- 5. Stop Recording

You can stop recording by pressing the [PLAY/STOP] button either in the Song part or auto accompaniment part, or pressing the [ENDING] button.

If the record is stopped, there is no REC signal in the screen.

Voice number and volume of the accompaniment show in the screen.



- 1. Selecting S. NUMBER

If needed, press the FUNCTION button to select the Song Number. Then use the [SEARCH] dial to select No. 5 (USER SONG)

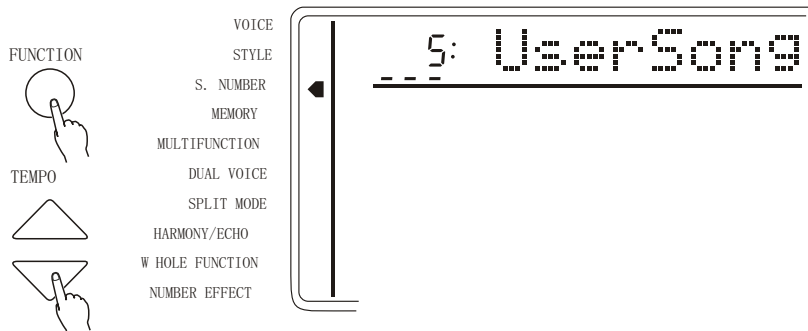

- 2. Start Playback

Press the [START/STOP] button, and you could open/close the accompaniment & melody tracks according to you need.

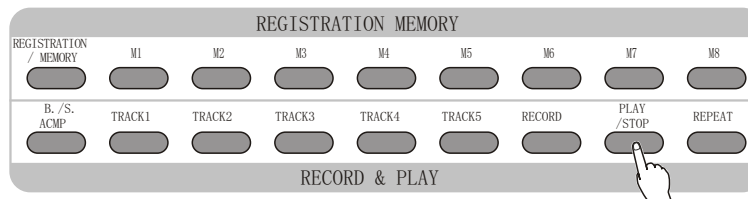

- 3. Stop Playback

The playback automatically stops at the end. You can also press the [START/STOP] button to stop the playback.

Notice:

Press the FUNCTION button to Song Track position, and use the Cursor (◀▶) buttons to select a certain track, and then use the CURSOR (◀▶) buttons and a roller to open/close this track. When closed, the track mark disappears. When the playback is on, the voice volume can be rewritten.

- 4. Rewriting the Voice & Volume

While playing, you could rewrite the setting of the voice of any track. After selecting a Voice number of one track (the mark flashes) by the Cursor buttons, use [SEARCH] dial to change the setting. The setting will soon work. The voice change in the record data will take effect at the same time.

While playing, you could rewrite the setting of the volume of any track. After selecting a volume of one track (the mark flashes) by the Cursor buttons, use the [SEARCH] dial to change the setting. The setting will soon work. The volume change in the record data will take effect at the same time.

Notice:

Only the Voice and Volume of the USER SONG can be rewritten.

PRACTICE FUNCTION

*. This instrument provides two functions to help you practice.

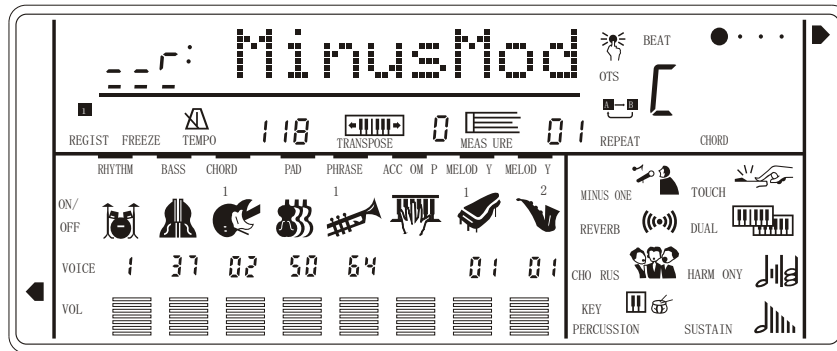

MINUS CHANNEL MODE

*. Under this mode, the left/right part of the keyboard of the DEMO could be closed. TO make you more convenient to follow the playing. "MinusMod" of the WHOLE FUNCTION has a parameter to control the channel.

Press the MINUS CHANNEL button to open this function. The relative mark appears in the screen.

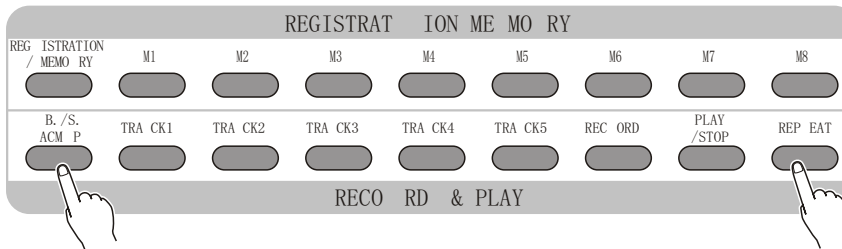

■ APPOINTING THE CHANNEL

Press the FUNCTION button to select WHOLE FUNCTION. (The "arrow" marks to the position). Then use the CURSOR button (▲▼) to select MinusMod parameter. Use the [SEARCH] dial to appoint the channel.

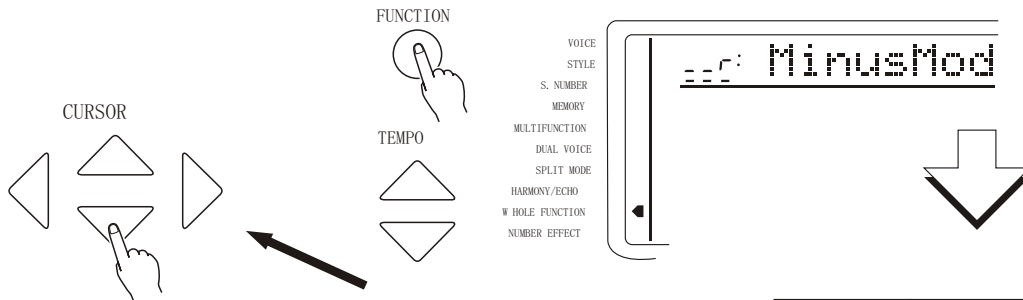

Mode	Part Turned Off
--r	Left MinusMod
L--	Right MinusMod
L-r	Both MinusMod

Notice:

Minus Channel Mode has no effect on the song you record by yourself.

Holding the MINUS CHANNEL button could quickly select the parameter of MinusMod.

When the power switch turns ON, this keyboard will automatically select (right hand MinusMod)

REPEATED PLAYBACK

*. This function lets you repeat a certain part of the song. During playback, press the [REPEAT] button at the beginning of your desired part (A shows in the screen) and press it again at its end (B shows in the screen). Then it will repeatedly play the part you desired until you press the [REPEAT] button again.

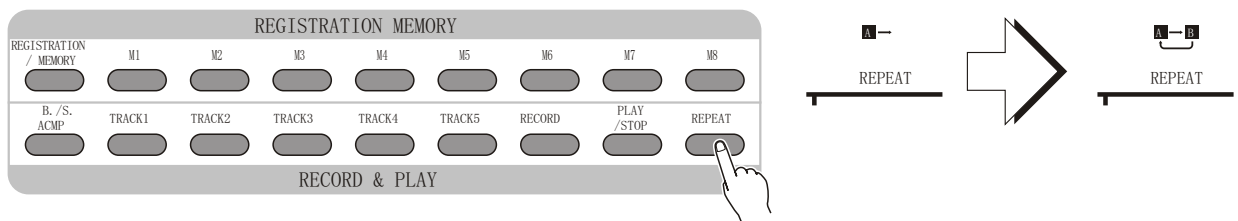

Also you can set the part you want to repeat even if the playback is off. Use measure parameter to set point A and then press the [REPEAT] button. Then set point B, and press [REPEAT] button again. Press the [START/STOP] button to start the playback of the part you desired.

Notice:

If you set the point A only, the repetition will start from A to the end.

For example, you set the point A at measure 2 and point B at measure 8, the repetition will play from measure 2 to 8.

WHOLE FUNCTION

Some of the operations in the WHOLE FUNCTION have been introduced before. But some have not. And we are going to introduce the new ones.

What displays in the screen are the abbreviations of the Functions. The following list the full names and their parameter extensions.

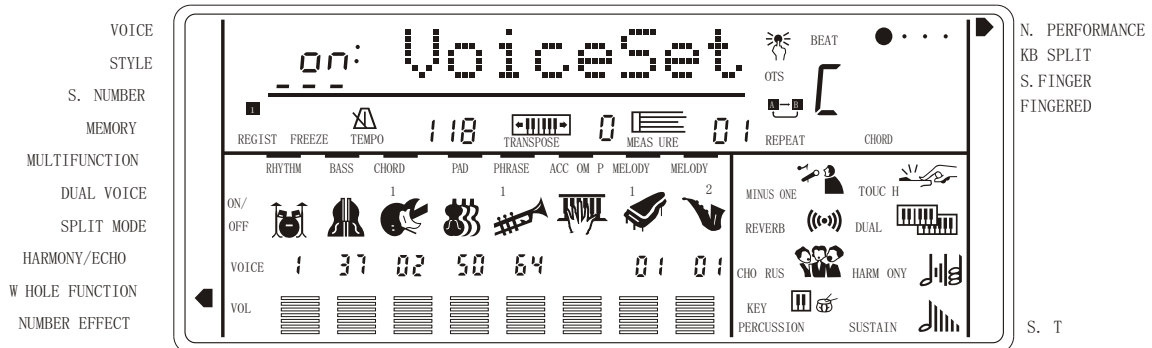

Function	Display	extension	Page No
Keyboard volume	KybdVo 1	00 ~ 127	47
8 Octave	Octave	-2 ~ 0 ~ 2	46
Reverb Level	ReverbLevel	00 ~ 127	46
Chorus Level	ChorusLevel	00 ~ 127	47
Pan	Pan	0 ~ 7	47
Voice set	VoiceSet	OFF, ON	47
Accompany volume	Acompvol	00 ~ 127	47
Accompany Separate point	AccSpPnt	00 ~ 127	35
Touch Sense	TouchSns	00 ~ 127	48
Minus mode	MinusMod	-r, L-, L-r	43
Minus channel right	MinusChR	01 ~ 16	48
Minus channel left	MinusChL	01 ~ 16	48
P B Range	PBRange	01 ~ 12	22
Metronome	Metronom	OFF, ON	48
Tuning	Tuning	-100 ~ 100	48
Remote channel	RemoteCh	OFF, 01 ~ 16	49
Keyboard output	KybdOut	OFF, ON	49
Keyboard Percussive	KBDPERC	01 ~ 10	15
3D Effect	3DEffect	OFF, ON	26

Press the FUNCTION button to select the WHOLE FUNCTION (The "arrow" marks the position). Use the CURSOR (▲▼) buttons to select the parameter you need and then use [SEARCH] dial to set the parameter

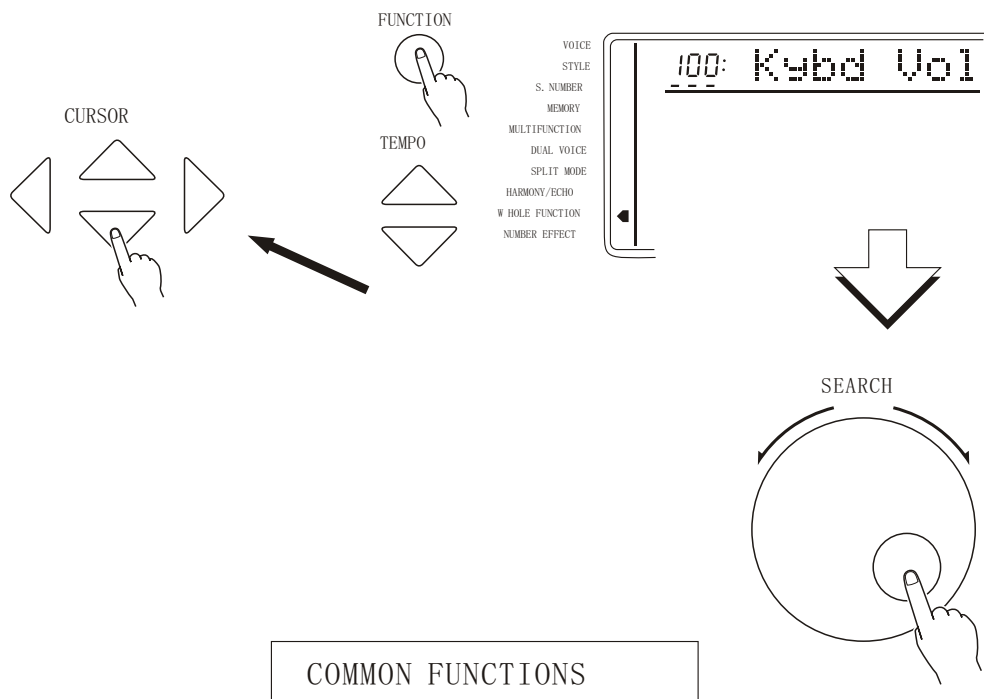

■ KEYBOARD VOLUME

To set the volume suitable to the accompaniment and playback. (including DUAL & SPLIT VOICE). Extension: 00 to 127. 00 stands for no sound, and 127 the highest Vol.

100: Kybd Vol

Notice:

Holding the [VOICE] button can quickly select this function.

Press both CURSOR (◀▶) buttons to return to the original volume setting (100).

■ 8 OCTAVE

To change the Octave pitch of the voice in the right part of the keyboard. -1 is to fall by an Octave, and -2 by Octaves, and +1, +2 to rise by one or two Octaves.

0: Octave

Notice:

Press both CURSOR (◀▶) buttons to return to the original volume setting (0).

■ REV LEVEL

To set the voice output to the REV LEVEL. Extension: 00-127. Return LEVEL is set by "SET RETURN REV LEVEL" above.

28: RevLevel

Notice:

Press both CURSOR (◀▶) buttons to return to the original volume setting (28).

■ CHORUS LEVEL

Setting the output to the CHORUS LEVEL. Extension: 00-127. Return chorus level is set by "SET RETURN CHO LEVEL" above.

```
| | 70: ChoLevel
```

Notice:

Press both CURSOR ◀ ▶ buttons to return to the original setting of Return CHO LEVEL (20).

■ PAN

To change voice stereo phase of the right part of the keyboard by the Voice function. Extension: -7(left)+7(right)

```
| | 0: Pan
```

Notice:

When the Voice Set is on, the PAN you select by VOICE is 0.
Holding the [Tempo -] and NUMBER buttons to input minus number.
Press both CURSOR ◀ ▶ buttons to return to the original setting.

■ VOICE SET

This function automatically sets the parameters which have great influence on voice, in order to create the best effect.

The following are the types of different parameters.

*. Octave *. REV LEVEL
*. CHO LEVEL *. KBDL

```
| | 00: VoiceSet
```

■ ACCOMPANIMENT VOLUME

To set suitable volume for Melody and Playback. Extension: 00-127. 00 stands for no sound and 127 the highest volume.

```
| | 100: AcompVol
```

Notice:

Hold the [STYLE] button quickly select this function.
Press both CURSOR ◀ ▶ buttons to return to the original volume setting (100).

■ TOUCH SENSITIVITY

When the Touch Response function is on, this parameter determines the touch sense. The bigger the number, the higher the sense.

```
| | 100: TouchSns
```

Notice:

Press both CURSOR ◀▶ buttons to return to the original volume setting (100). Holding down the [TOUCH] button can quickly select this function.

■ MINUS CHANNEL

You can make the Song (DEMO) Minus counterpoint to the passage. By closing the passage you can close the Minus during your practice.

```
| | 01: MinusChR
```

```
| | 02: MinusChL
```

Notice:

Passage 1-16 is available. Press both CURSOR ◀▶ buttons to return to the original number setting (01 for right hand, 02 for left hand).

■ METRONOME

You can open/close this function. When it is open, Metronome sounds with the function under accompany/User song and recording.

```
| | OFF: Metronom
```

Notice:

When the power switch turns on, this function is closed.

■ PITCH

Adjusting the Pitch a little bit to fit other musical instruments. Extension is from -100 to 100. 00 is the standard Pitch.

Notice:

Press both CURSOR ◀▶ buttons to return to the original setting (00).

MIDI FUNCTIONS

MIDI FUNCTION

MIDI is an international standard. It connects musical instruments that have this function in order to control and transmit data to each other. Thus, it makes all the instrument a big system and greatly enlarge the whole function.

■ MIDI INTERFACE

MIDI IN receives the data from the outside devices to control this keyboard.

MIDI OUT transmits the data from this keyboard (not of the keyboard and Touch data)

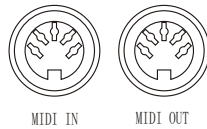

Notice:

MIDI connection cable should be no longer than 15m. Otherwise, wrong data and noise may occur.

■ REMOTE PASSAGE

To set the MIDI passage from which outside keyboard data is sent, you could select 01-16. The outside keyboard must settle the passage from which data is sent. Its MIDI OUT connects this keyboard's MIDI IN by MIDI cable. When the setting is OFF, this keyboard will receive from all 16 passages. Press both Tempo + & - buttons to return to the original setting (OFF)

OFF: RemoteCh

■ KEYBOARD OUTPUT

To determine whether the data output from the MIDI OUT.

OFF: RemoteCh

APPENDIX

VOICE LIST

This instrument has 64-note maximum polyphony. This means that it can play a maximum of up to 64 notes at once, regardless of what functions are used. Accompaniment uses a number of the available notes, so when Accompaniment is used the total number of available notes for playing on the keyboard is correspondingly reduced. The same applies to the Split Voice and Song functions.

Caution: The Voice List includes MIDI program change numbers for each voice. Use these program change numbers when playing this instrument via MIDI from an external device.

Voice No	MIDI No	Name of Voice	中文名称
PIANO 钢琴			
01	0	ACOUSTIC GRAND PIANO	原声大钢琴
02	1	BRIGHT ACOUSTIC PIANO	亮原声钢琴
03	2	ELECTRIC GRAND PIANO	电子大钢琴
04	3	HONKY-TONK PIANO	酒吧钢琴
05	4	ELECTRIC PIANO1	电钢琴1
06	5	ELECTRIC PIANO2	电钢琴2
07	6	HARPSICHORD	拨弦古钢琴
08	7	CLAVI	击弦古钢琴
CHROMATIC PERCUSSION 打击乐器			
09	8	CELESTA	钢片琴
10	9	GLOCKENSPIEL	钟琴
11	10	MUSIC BOX	音乐盒
12	11	VIBRAPHONE	振琴
13	12	MARINBA	马林巴
14	13	XYLOPHONE	木琴
15	14	TUBULAR BELLS	管钟
16	15	DULCIMER	洋琴
ORGAN 风琴			
17	16	DRAWBAR ORGAN	卓芭风琴
18	17	PERCUSSIVE ORGAN	打击风琴
19	18	ROCK ORGAN	摇滚风琴
20	19	CHURCH ORGAN	教堂风琴
21	20	FEED ORGAN	簧片风琴
22	21	ACCORDION	手风琴
23	22	HARMONICA	口琴
24	23	TANGO ACCORDION	探戈手风琴
GUITAR 吉它			
25	24	ACOUSTIC GUITAR (NYLIN)	尼龙弦吉它
26	25	ACOUSTIC GUITAR (STEEL)	钢弦吉它
27	26	ELECTRNIC GUITAR (JAZZ)	爵士电吉它
28	27	ELECTRNIC GUITAR (CLEAN)	清音电吉它
29	28	ELECTRNIC GUITAR (MUTED)	弱音电吉它
30	29	OVERDRIVEN GUITAR	夸张吉它
31	30	DISTOTION GUITAR	失真吉它
32	31	GUITAR HARMONICS	吉它泛音
BASS 贝司			
33	32	ACOUSTIC BASS	古典贝司
34	33	ELECTRIC BASS (FINGER)	指弹电贝司
35	34	ELECTRIC BASS (PICK)	拨片电贝司
36	35	FRETLESS BASS	无品贝司
37	36	SLAP BASS1	打弦贝司1
38	37	SLAP BASS2	打弦贝司2
39	38	SYNTH BASS1	合成贝司1
40	39	SYNTH BASS2	合成贝司2

Voice No	MIDI NO	Name of Voice	中文名称
STRINGS 弦乐			
41	40	VIOLIN	小提琴
42	41	VIOLA	中提琴
43	42	CELLO	大提琴
44	43	CONTRABASS	低音提琴
45	44	TREMOLO ATRINGS	震音弦乐
46	45	PIZZICATO STRINGS	拨奏弦乐
47	46	ORCHESTRAL HARP	竖琴
48	47	TIMPANI	定音鼓
RNSEMBLE 合奏			
49	48	STRINGS ENSEMBLE1	弦乐合奏1
50	49	STRINGS ENSEMBLE12	弦乐合奏2
51	50	SYNTH STRINGS1	合成弦乐1
52	51	SYNTH STRINGS2	合成弦乐2
53	52	CHOIR AAHS	唱音 啊
54	53	VOICE OOHS	人声 噢
55	54	SYNTH VOICE	合成成人声
56	55	ORCHESTRA HIT	管弦乐齐奏
BRASS 铜管			
57	56	TRUMPET	小号
58	57	TROMBONE	长号
59	58	TUBA	大号
60	59	MUTED TRUMPET	弱音小号
61	60	FRENCH HORN	圆号
62	61	BRASS SECTION	铜管乐队
63	62	SYNTH BRASS1	合成铜管乐1
64	63	SYNTH BRASS2	合成铜管乐2
REED 簧管乐器			
65	64	SOPRANO SAX	高音萨克斯
66	65	ALTO SAX	中音萨克斯
67	66	TENOR SAX	次音萨克斯
68	67	BARTION SAX	低音萨克斯
69	68	OBOE	双簧管
70	69	ENGLISH HORN	英国管
71	70	BASSOON	巴松管
72	71	CLARINET	单簧管
PIPE 木管乐器			
73	72	PICCOLO	短笛
74	73	FLUTE	长笛
75	74	RECORDER	竖笛
76	75	PAN FLUTE	排箫
77	76	BLOWN BOTTLE	吹瓶
78	77	SHAKUHACHI	尺八
79	78	WHISTLE	口哨
80	79	OCARINA	奥卡利那笛

VOICE LIST

Voice No	MIDI No	Name of Voice	中文名称
SYNTH REED 合成管乐器			
81	80	LEAD1 (WOUARE)	方波管乐
82	81	LEAD2 (SAWTIITH)	锯齿波管乐
83	82	LEAD3 (CALLIOPE)	蒸汽琴管乐
84	83	LEAD4 (CHIFF)	雪坊管乐
85	84	LEAD5 (CHARANG)	沙朗管乐
86	85	LEAD6 (VOICE)	人声管乐
87	86	LEAD7 (FIFTH)	五度管乐
88	87	LEAD8 (BASS+LEAD)	贝司管乐
SYNTH PAD 合成背景音色			
89	88	PAD1 (NEW AGE)	新世纪垫
90	89	PAD2 (WARM)	温暖音色垫
91	90	PAD3 (POL YSYNTH)	聚合成音色垫
92	91	PAD4 (CHOIR)	唱诗垫
93	92	PAD5 (BOWED)	弓弦音色垫
94	93	PAD6 (MET ALLIC)	金属音色垫
95	94	PAD7 (HALO)	环形音色垫
96	95	PAD8 (SWEEP)	掠扫音色垫
SYNTH EFFECTS 合成效果音色			
97	96	FX1 (RAIN)	雨
98	97	FX2 (SOUNDTRACK)	声轨
99	98	FX3 (CRYSTAL)	水晶
100	99	FX4 (ATMOSPHERE)	大气
101	100	FX5 (BRIGHTNESS)	闪亮
102	101	FX6 (GOBLINS)	小妖怪
103	102	FX7 (ECHOES)	回声
104	103	FX8 (SCO-FI)	科幻
ETHNIC 民族乐器			
105	104	SITAR	西塔尔
106	105	BANJO	班卓琴
107	106	SHAMISEN	三弦
108	107	GUZHENG	古筝
109	108	KALIMBA	卡林巴
110	109	BAGPIPE	风笛
111	110	ERHU	二胡
112	111	SUONAI	唢呐
PERCUSSION 打击乐器			
113	112	TINKLE BELL	响铃
114	113	AGOGO	啊果果
115	114	STEEL DRUMS	钢鼓
116	115	WOODBLOCK	盒梆
117	116	TAIKO DRUM	日本鼓
118	117	MELODIC TOM	旋律鼓
119	118	SYNTH DRUM	合成鼓
120	119	REVERSE CYMBAL	反钹

Voice No	MIDI No	Name of Voice	中文名称
SOUND EFFECT 效果音色			
121	120	FRET NOSE	弦马杂音
122	121	BREATH NOISE	呼吸音
123	122	SEASHORE	海滨
124	123	BIRD TWEET	小鸟叫声
125	124	TELEPHONE RING	电话铃
126	125	HELICOPTER	直升飞机
127	126	APPLAUSE	喝彩
128	127	GUNSHOT	枪声
FOLK 民乐音色			
129	128	YUNLUO	云锣
130	129	GUANMEILANG	甘美郎
131	130	BIANMANG	编铙
132	131	YANGQIN	扬琴
133	132	LUSHENG	芦笙
134	133	PIBA	琵琶
135	134	LUOQIN	柳琴
136	135	YUQIN	月琴
137	136	DARUAN	大阮
138	137	ZHONGRUAN	中阮
139	138	GUOHU	高胡
140	139	ERHU	二胡
141	140	ZHONGHU	中胡
142	141	ERHUQUN1	二胡群1
143	142	ERHUQUN2	二胡群2
144	143	ZHONGHUQUN	中胡群
145	144	BANGDI	梆笛
146	145	KUNDI	昆笛
147	146	XIAO	箫
148	147	BANHU	板胡
149	148	XIPI	西皮
150	149	ZHUIHU	坠胡
151	150	SANXIAN	三弦
152	151	GUZHENG	古筝
153	152	GUOYINSUONA	高音唢呐
PERCUSSION 打击乐			
154	153	STANDARD DRUMS	标准鼓组
155	154	CHINESE PERCUSSION	中国打击乐组
156	155	ROOM DRUMS	房间鼓组
157	156	ROCK DRUMS	摇滚鼓组
158	157	ELECTRIC DRUMS	电子鼓组
159	158	T 808 DRUMS	T808 鼓组
160	159	JAZZ DRUMS	爵士鼓组
161	160	BRUSH KIT	刷子鼓组
162	161	CLASSIC DRUMS	古典鼓组
163	162	SFX KIT	效果鼓组

STYLE LIST

No	Name	中文名
8/16BEAT 8/16拍		
00	8BEAT -1	8拍1
01	8BEAT -2	8拍2
02	8BEAT -3	8拍3
03	16BEAT -1	16拍1
04	16BEAT -2	16拍2
05	16BEAT -3	16拍3
POP 流行乐		
06	POOPROCK	流行摇滚
07	FOLKROCK	民歌风摇滚
08	POPBOLERO	流行波莱罗
09	POPWALTZ	流行华尔兹
10	SOULBALLAD	流行民谣
11	MOOTOWN	底特律节奏
DANCE 舞曲		
12	HOUSE	家庭舞曲
13	TECHNO-1	现代舞曲 1
14	TECHNO-2	现代舞曲 2
15	RAVE	拉布
16	DANCE-1	舞曲 1
17	DANCE-2	舞曲 2
18	DISCO-70S	70年代迪斯科
19	DISCO	迪斯科
20	MACARENA	马卡伦那
R&B 蓝调摇滚		
21	GOSPEL-1	黑人福音音乐 1
22	GOSPEL-2	黑人福音音乐 2
23	R&B-1	蓝调摇滚 1
24	R&B-2	蓝调摇滚 2
25	BLUES-1	布鲁斯 1
26	BLUES-2	布鲁斯 2
27	FUNK	早期爵士乐
ROCK 摇滚乐		
28	ROCK-60S	60年代摇滚
29	ROCK-70S	70年代摇滚
30	ROCK-80S	80年代摇滚
31	BALL ROCK	舞会摇滚
32	SLOW ROCK	慢摇滚
33	SLOW ROCK 6/8	慢摇滚 6/8
ROCK&ROLL 快速摇滚乐		
34	ROCK&ROLL-1	快速摇滚 1
35	ROCK&ROLL-2	快速摇滚 2
36	SHUFFLE	滑曳摇滚
37	TWIST	扭扭舞
38	BOOGIE-1	布吉乐 1
39	BOOGIE-2	布吉乐 2
SWING/JAZZ 摇摆舞/爵士		
40	SWING	摇摆舞
41	LOUNGE	悠闲爵士
42	DIXIE-1	新奥尔良爵士 1
43	DIXIE-2	新奥尔良爵士 2
44	JAZZ BALLAD-1	舞会爵士乐 1
45	JAZZ BALLAD-2	舞会爵士乐 2
46	JAZZ WALTZ	爵士华尔兹
47	CHARLSTON	查尔斯顿舞
48	RAGTIME	早期爵士乐
COUNTRY 乡村音乐		

NO	Name	中文名
49	COUNTRY-1	乡村音乐 1
50	COUNTRY-2	乡村音乐 2
51	COUNTRY DANCE	乡村舞曲
52	COUNTRY ROCK	乡村摇滚
53	COUNTRY WALTZ	乡村华尔兹
CARIBBEAN 加勒比音乐		
54	REGGAE-1	雷格 1
55	REGGAE-2	雷格 2
56	CARIBBEAN	加勒比节奏
LATIN-1 拉丁 1		
57	BOSSA-1	波萨诺瓦 1
58	BOSSA-2	波萨诺瓦 2
59	SAMBA-1	桑巴 1
60	SAMBA-2	桑巴 2
61	RUMBA	伦巴
62	BEGUINE	贝津舞
63	CHA CHA-1	恰恰 1
64	CHA CHA-2	恰恰 2
LATIN-2 拉丁 2		
65	SALSA	萨尔萨舞曲
66	CUMBIA	巴西舞曲
67	MERENQUE	美伦格舞
68	MAMBO	曼波舞曲
69	LATIN	拉丁舞曲
70	GIPSY	吉普赛舞
71	D. SAMBA	迪斯科桑巴
ORIENTAL 东方舞曲		
72	CINGENE	阿拉伯舞曲
73	MUS 5/8	土耳其舞曲
74	ORIENTAL	东方舞曲
75	OYUNHAV A	小亚细亚舞曲
WORLD MUSIC 世界音乐		
76	SEVILLIANA	赛尔维利亚舞曲
77	HOLLYWOOD	好莱坞
78	SP. RUMBA	西班牙伦巴
79	SP. BOLERO	西班牙波莱多
80	SIRTAKI	希腊舞曲
81	BAROQUE	巴洛克
82	HAWAII	夏威夷舞曲
BALLROOM 交谊舞曲		
83	FOXTROT	狐步舞曲
84	QUICKSTEP	快步舞
85	SLOWFOX	慢狐步舞
86	TRAD. WALTZ	传统华尔兹
87	JIVE	轻快爵士
88	PASODOBLE	平舞土舞
89	TANGO	探戈
90	TANGO A RG	阿根廷探戈
WALTZ/MARCH 华尔兹进行曲		
91	GERM WALTZ	德国华尔兹
92	VIENNA WALTZ	维也纳华尔兹
93	MUSETTE	风笛舞
94	SLOW WALTZ	慢速华尔兹
95	MARCH	进行曲
96	MARCH 6/8	进行曲 6/8
97	POLKA	波尔卡
98	D. POLKA	迪斯科波尔卡
99	SCHLAGER	德国进行曲

DRUM SET TABLE (MIDI CHANNEL 10)

	1 HQ STD SET1	2 CHINESE SET	3 HQ ROOM SET	4 HQ POWER SET	5 HQ ELEC. SET
39 - D#2	High Q				
40 - E2	Slap				
41 - F2	Scratch Push				
42 - F#2	Scratch Pull				
43 - G2	Sticks				
44 - G#2	Square Click				
45 - A2	Metronome Click				
46 - A#2	Metronome Bell				
47 - B2	HQ STD1 Kick2		HQ Room Kick2	HQ Power Kick2	HQ Elec Kick2
48 - C3	HQ STD1 Kick1		HQ Room Kick1	HQ Power Kick1	HQ Elec Kick1
49 - C#3	Side Stick				
50 - D3	HQ STD1 Snare1		HQ Room Snare1	Gated Snare	Elec SD
51 - D#3	Hand Clap				
52 - E3	Snare Drum 2		HQ Room Snare1	HQ Power Snare1	HQ Elec Snare1
53 - F3	HQ Low Floor Tom	大鼓 1	HQ Power Low Tom2	HQ Power Low Tom2	Elec Low Tom2
54 - F#3	Closed Hi Hat [EXC1]				
55 - G3	HQ High Floor Tom	大鼓 2	HQ Power Low Tom1	HQ Power Low Tom1	Elec Low Tom1
56 - G#3	Pedal Hi-Hat [EXC1]				
57 - A3	HQ Low Tom	中鼓 1	HQ Power Mid Tom2	HQ Power Mid Tom2	Elec Mid Tom2
58 - A#3	Open Hi-Hat [EXC1]				
59 - B3	HQ Low-Mid Tom	中鼓 2	HQ Power Mid Tom1	HQ Power Mid Tom1	Elec Mid Tom1
60 - C4	HQ Hi Mid Tom	小鼓 1	HQ Power Hi Tom2	HQ Power Hi Tom2	Elec Hi Tom2
61 - C#4	Crash Cymbal 1				
62 - D4	HQ High Tom	小鼓 2	HQ Power Hi Tom1	HQ Power Hi Tom1	Elec Hi Tom1
63 - D#4	Ride Cymbal 1				
64 - E4	Chinese Cymbal	小堂锣			Reverse Cymbal
65 - F4	Ride Bell	汤锣 1			
66 - F#4	Tambourine	闭小钹			
67 - G4	Splash Cymbal	汤锣 2			
68 - G#4	Cowbell	哑锣			
69 - A4	Crash Cymbal 2	低音堂锣			
70 - A#4	Vibraslap	大堂锣			
71 - B4	Ride Cymbal 2	开小钹			
72 - C5	Hi Bongo				
73 - C#5	Low Bongo				
74 - D5	Mute Hi Conga				
75 - D#5	Open Hi Conga				
76 - E5	Low Conga				
77 - F5	High Timbale	腰鼓 1			
78 - F#5	Low Timbale	腰鼓 2			
79 - G5	High Agogo	木鱼			
80 - G#5	Low Agogo	梆子			
81 - A5	Cabasa				
82 - A#5	Maracas				
83 - B5	Short Whistle[EXC2]				
84 - C6	Long Whistle[EXC2]				
85 - C#6	Short Guiro [EXC3]				
86 - D6	Long Guiro [EXC3]				
87 - D#6	Claves				
88 - E6	Hi Wood Block				
89 - F6	Low Wood Block				
90 - F#6	Mute Cuica [EXC4]				
91 - G6	Open Cuica [EXC4]				
92 - G#6	Mute Triangle[EXC5]				
93 - A6	Open Triangle[EXC5]				
94 - A#6	Shaker				
95 - B6	Jingle				
96 - C7	Belltree				

DRUM SET TABLE (MIDI CHANNEL 10)

	6 HQ TR808 SET	7 HQ DANCE SET	8 BRUSH	9 ORCHESTRA	10 SFX SET
39 - D#2				Closed Hi Hat	*
40 - E2				Pedal Hi-Hat	*
41 - F2				Open Hi Hat	*
42 - F#2				Ride Cymbal	*
43 - G2					*
44 - G#2					*
45 - A2					*
46 - A#2					*
47 - B2	HQ 909 BD	HQ Dance Kick	Jazz BD2	Concert BD 2	*
48 - C3	HQ 808 BD	HQ Elec Kick2	Jazz BD1	Concert BD 1	*
49 - C#3	808 Rim shot				*
50 - D3	808 Snare Drum	HQ Dance snare1	Brush Tap	Concert SD	*
51 - D#3			Brush Slap	Castanets	High Q
52 - E3	HQ 909 Snare	HQ Dance snare2	Brush Swirl	Concert SD	Slap
53 - F3	808 Low Tom2	Elec Low Tom2		Timpani F	Scratch Push
54 - F#3	808 CHH [EXC1]	808 CHH [EXC1]		Timpani F#	Scratch Pull
55 - G3	808 Low Tom2	Elec Low Tom1		Timpani G	Sticks
56 - G#3	808 CHH [EXC1]	808 CHH [EXC1]		Timpani G#	Square Click
57 - A3	808 Mid Tom2	Elec Mid Tom2		Timpani A	Metronome Click
58 - A#3	808 OHH [EXC1]	808 OHH [EXC1]		Timpani A#	Metronome Bell
59 - B3	808 Mid Tom1	Elec Mid Tom1		Timpani B	Guitar Slide
60 - C4	808 Hi Tom2	Elec Hi Tom2		Timpani c	Gt Cut Noise (down)
61 - C#4	808 Cymbal			Timpani c#	Gt Cut Noise (up)
62 - D4	808 HiTom1	Elec Hi Tom1		Timpani d	Double Bass Slap
63 - D#4				Timpani d#	Key Click
64 - E4		Reverse Cymbal		Timpani e	Laughing
65 - F4				Timpani f	Screaming
66 - F#4					Punch
67 - G4					Heart Beat
68 - G#4	808 Cowbell				Footsteps1
69 - A4				Concert Cymbal2	Footsteps2
70 - A#4					Applause
71 - B4				Concert Cymbal1	Door Creaking
72 - C5					Door Closing
73 - C#5					Scratch
74 - D5	808 High Conga				Wind Chime
75 - D#5	808 Mid Conga				Car Engine Start
76 - E5	808 Low Conga				Car Breaking
77 - F5					Car Pass
78 - F#5					Car Crash
79 - G5					Police Siren
80 - G#5					Train
81 - A5					Jet Take-off
82 - A#5	808 Maracas				Helicopter
83 - B5					Starship
84 - C6					Gun Shot
85 - C#6					Machinegun
86 - D6					Lasergun
87 - D#6	808 Claves				Explosion
88 - E6					Dog
89 - F6					Horse Gallop
90 - F#6					Birds
91 - G6					Rain
92 - G#6					Thunder
93 - A6					Wind
94 - A#6					Sea Shore
95 - B6					Stream
96 - C7					Bubble
					*
					*
					*
					*

TECHNICAL SPECIFICATIONS

Keyboard

- ! Deluxe version: 88-key keyboard with hammer action
- ! Economic version: 88-key keyboard with standard touch response.

Voice

- ! 348 PCM voices
- ! Max polyphony note: 64 notes
- ! Keyboard percussion: 1~9 groups
- ! Sound effect: 1 group
- ! Volume: 00~27
- ! Octachord: -2~2
- ! Phase: -7~7
- ! Keyboard Split: left & right hand voice
- ! Harmony and echo: 10 styles
- ! DSP reverb styles: 8 styles
- ! DSP chorus styles: 8 styles
- ! DSP reverb and chorus send level: 00~127
- ! DSP reverb and chorus return level: 00~127

Auto Accompaniment Function

- ! 100 styles
- ! Accompaniment track: rhythm, bass, rhythmic chord, long chord, sentence 1 / 2
- ! Large & small accompaniment mode
- ! Accompaniment track setting: ON / OFF, voice, volume
- ! Accompaniment control: SYNCHRO, Intro, Main A & B, Auto Fill & B, ending, start / stop
- ! Tempo: 40~240
- ! Accompaniment volume: 00~127
- ! Accompaniment split

Songs

- ! 4 demo songs and 1 user song

Song Record

- ! 3 record tracks

Accompaniment Mode

- ! Normal Performance, keyboard split, single finger, fingered

Panel Parameter Memory Bank

- ! 8 banks, accompaniment freeze

Total Function

- ! Transpose: -12~+12
- ! Metronome: ON & OFF

Display

- ! 122 * 50mm large LCD screen

Control Buttons

- ! Up & down & right & left cursors, up & down function buttons, mode button, numeric buttons 0~9
- ! MIDI function: receive and send

Auxiliary Interfaces

- ! DC input, foot switch
- ! Deluxe version: 3 Pedals.

Power Output

- ! 45W+45W
- ! Earphone output: resistance output-32ohm
- ! Loudspeaker: 16.5cm*2+5cm*2, 4 ohm
- ! Voltage: 15V DC

Packing Information

- ! Dimension: 1470(L)*420(W)*190(H)mm
- ! Deluxe Version: G. /N.W: 43kg/38kg
- ! Economic Version: G.W. /N. W. : 33kg/28kg

Complimentary Accessories

- ! Screws, screw caps, screw washers
- ! Music Stand
- ! Power supply cable
- ! Owners manual
- ! Warranty card

The specifications are subject to change without notice.

WELCOME ...

To the happy family of satisfied WORLD electronic musical instrument owners! Get the most out of the many features and functions of the keyboard, please to read carefully this manual and keep it at hand for future reference.

MAIN FEATURES

- Strong multifunctional LCD system with large-screen display, which makes selecting and editing parameters much easier.
- 153 different kinds of voices, including voices of Chinese folk instruments (Trichord, Gu-Zheng, Erhu, Suona)
- Almost including 100 popular accompaniment styles in the world. Each rhythm has its own intro and main (A, B two types) variation and ending.
- 32 types of commonly-used voices and 32 types of commonly-used styles for rapid choice.
- With 9 groups of percussion instrument and special-effect-voice group, including group of Chinese traditional percussion instrument.
- Song Recording function can record one accompaniment track and two melody tracks.
- Soft LCD back light makes the piano more luxurious.
- Be able to synthesize certain digital effects like the reverb, chorus, and 3 D stereo effect, which could create various sound field effects.
- Be able to record one user song.
- Beautiful demo songs, making great contributions to lifting performance level.
- Memory Bank can reserve at most 8 panel parameter settings and each setting can be recalled whenever you want.
- Minus Channel Mode and Repeated Playback function are excellent for teaching and practising.



WORLDDE

W2000H Owners Manual

Company Add:
Room G&H, 7F , Twer B, Guoji Garden,
160 Tian Mushan Road, Hangzhou, Zhejiang, 310012,
P. R. China
TEL: +86-571-88211880 8821653
FAX: +86-571-88211886

E-mail: sales@worldde.com.cn
support@worldde.com.cn
Website: www.WORLDDE.com.cn

HANGZHOU WORLDDE DIGITAL PIANO CO., LTD

Owner's Manual