

WELCOME...

To the happy family of WORLDE electronic musical instrument owners! To get the most out of the many features and functions of the keyboard, please be sure to read carefully this manual and keep it at hand for future reference.

MAIN FEATURES

- Strong multifunctional LCD system with large-screen display of Chinese characters, which makes selecting and editing parameters much easier.
- 163 different kinds of voices, including 128 GM sounds, 25 voices of Chinese folk instruments and also 10 percussion groups.
- Almost including 100 popular accompaniment styles in the world. Each has its own intro and main (A, B two types), variation and ending.
- 48 types of commonly-used voices and 24 types of commonly-used styles for rapid choice.
- With 9 groups of percussion instrument and a group of Chinese traditional percussion instrument.
- Soft LCD back light makes the piano more luxurious.
- Be able to synthesize certain digital effects like the reverb, chorus, and 3 D stereo effect, which could create various sound field effects.
- Be able to record at most 5 user songs, and they could be played repeatedly.
- 22 demonstration songs, making great contributions to lifting your performance level.
- Panel-register function could save your beloved panel, and recall it whenever you want.

CONTENTS

Safety Precautions	P. 2	■SYNCHRO Start	P.13
Panel Controls and Terminals	P.3	■SYNCHRO Stop	P.16
Preparations	P.5	Accompaniment Sections (Main A/B & fill-ins)	
■Power	P.5	P.17
●AC Adapter	P.5	Chord	P.18
■Connection	P. 5	Using Auto Accompaniment—Multi fingering	
●USB interface	P. 5	P.18
●Audio Output and Headphone	P. 5	Percussion	P.20
●Sustain Jack Terminal	P. 6	■Keyboard Percussion	P.20
●MIDI Input and Output	P. 6	Song Memory	P.21
Playing the Piano	P.7	Song Recording	P.22
■Starting to Play the Piano	P.7	■Recording a User Song	P.22
■DEMO Songs	P.7	■Song Clear	P.25
●Playing all Songs	P.7	■Track Clear	P.26
●Playing a Single Selected Song	P.7	■Playing a Song	P.27
■Voice	P7	■A-B repeat	P.28
●Playing Voices	P.7	Registration Memory	P.30
■Dual Voice	P.7	■Recording a Registration Memory Preset	
●Balancing the Dual	P.7	P.30
■Control and Effect	P.8	■Recalling a Registration Memory Preset	
●Pitchbend Wheel	P.8	P.31
●Modulation Wheel	P.8	MIDI Functions	P.32
●Touch Respond	P.9	■What Is MIDI?	P.32
●Reverb	P.9	■MIDI Functions	P.33
●Tuning	P.9	■Connecting to a PC	P.34
●Transpose	P.10	Appendix	P.35
●Harmony	P.10	Voice List	P.35
Auto Accompaniment	P.11	Rhythm List	P.36
■Selecting a Style	P.11	Percussion List	P.38
■Adjusting the Accompaniment Volume	P.11	Technique Specifications	P.40
■Changing the Tempo	P.11		
■Playing the Accompaniment	P.12		

SAFETY PRECAUTIONS...

- Locations:
 - Avoid exposure to sunlight.
 - Do not place the item in or near overheated places like car or oven for a long time.
 - Do not place the item in places of moisture, dirty and vibrated.
 - Do not place the item near facilities with strong electromagnetic such as television and radio.

- Avoid strong crash and scratches with hard object.

- Turn off the power supply when not in use. If the item is not in use for a long time, please plug out the power supply cable to avoid any accident.

- Cut the power supply if any of the followings occur:
 - Power supply cable is damaged.
 - Fluid is splashed into/onto the item.
 - Thundering.

- When cutting the power supply, plug out the power socket, rather than pull the cable.

- When connecting to an external power supply, mind the maximum rated power.

- Clean the item with soft and clean cloths. Few amounts of neutral cleanser could be used, but never use solvents which would damage the finishing of the piano, such as alcohol, benzene, paint, or diluent.

PANEL CONTROLS AND TERMINALS

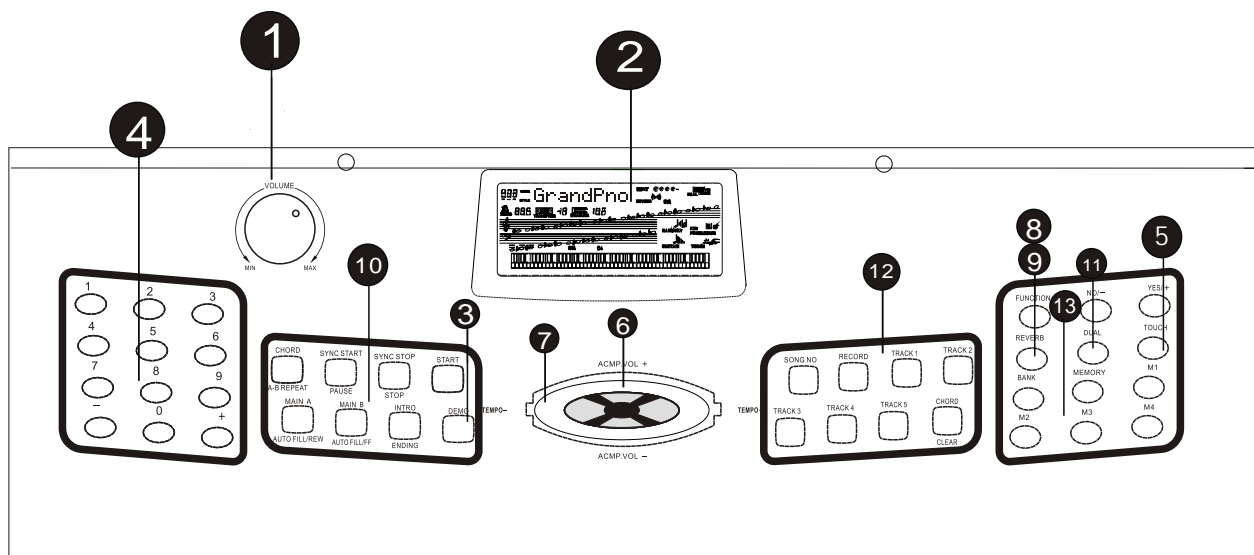

1. [MASTER VOLUME] dial

This determines the overall volume of W3000H.

2. LCD screen

3. [DEMO] button

This is to turn on/off demo function.

4. Numeric buttons [1] to [9] and [+] and [-] buttons

This is to select different voices, styles, and functions.

5. [TOUCH] button

This is to turn on/off Touch function.

6. [ACMP VOLUME] button

It is to control the volume of the accompaniment.

7. [TEMPO] button

It is to control the tempo of the accompaniment and the demo songs.

8. [FUNCTION] button

This is to select different functions.

9. [REVERB] button

This is to turn on / off the reverberation.

10. Auto accompaniment buttons

● [SYNC START]/[PAUSE] button

It is to turn on / off the SYNC Start function in accompaniment mode; and to temporarily pause song playback in Song mode.

● [SYNC STOP] button

It is to turn on / off the SYNC Stop function.

● [START]/[STOP] button

It is to start / stop the auto accompaniment in Style mode; and to start / stop song playback in Song mode.

● [MAIN A] / [AUTO FILL/REW] button

It is to control the auto fill and change the auto accompaniment sections while in Style mode; and fast rewind the song or move the song playback point back toward the beginning in Song mode.

● [MAIN B]/[AUTO FILL/FF] button

It is to control the auto fill and change the auto accompaniment sections while in Style mode;; and when Song mode is selected, this is used as a “ fast forward” control, or move the song playback point toward the end.

● [INTRO]/[ENDING] button

It is to control the Intro / Ending function in Style mode; and when the Song mode is selected, this is used as a “rewind” control, or move the song playback point back toward the beginning.

● [CHORD/A-B REPEAT] button

11. [DUAL] button

This is to turn on/off dual function.

12. SONG MEMORY buttons

These buttons ([Record], [1]-[5], [A]) are used for song recording, letting you record up to six different tracks of a song(including a special Chord track).

13. REGISTRATION MEMORY buttons

These buttons ([MEMORY], [BANK], [1]-[4]) are used for selecting and recording the Registration Memory presets

14. Sustain pedal jack

This is for connection to an optional FC4 or FC5 Sustain pedal for control over sustain, just like the damper pedal on a piano.

15. Headphone jack

This is for connection to a set of stereo headphones or to an external amplifier / speaker system.

16. Audio Output

This is to connect to an external stereo amplification system to amplify the sound.

17. USB interface

This is for connection to a USB cable between PC and the piano.

18. DC IN 12V jack

This is for connection to a PA-51 (accessory) power adaptor.

19..Power switch

This is to turn on/off the piano.

20.MIDI IN, OUT terminals

These two jacks are to connect to other MIDI instruments and devices.

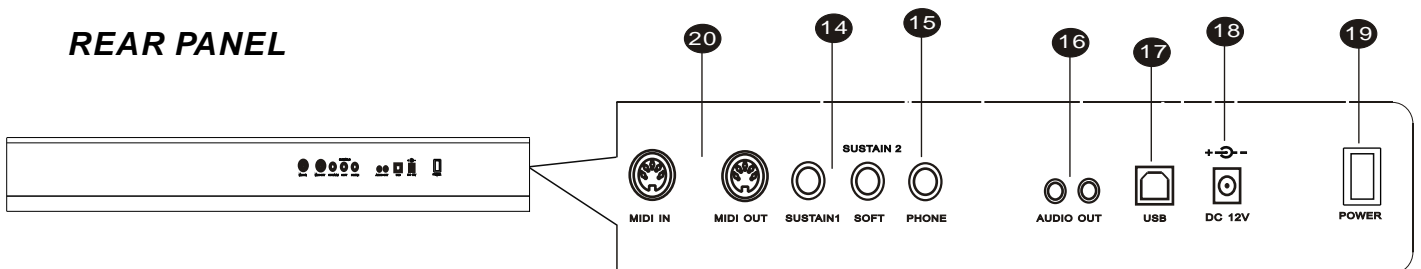

PREPARATIONS

■ Power Supply

This instrument will run either from an AC adaptor

If this instrument sounds totally different while playing at a high volume, this indicates the power supply run low.

Using an AC Power Adapter

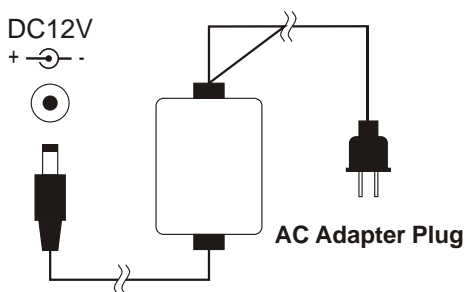

This instrument could be supplied with alternating current power, by connecting the output terminal of the adapter with DC 12V power input jack, and etc. When this instrument is connected with the adapter, the internal power circuit of this instrument would be automatically cut off.

■ USB interface



USB 1.1

Compatible with XP, MAC SOX.

Compatible with main pro audio and sequence softwares such as CAKEWALK and SONAR.

■ AUDIO OUTPUT

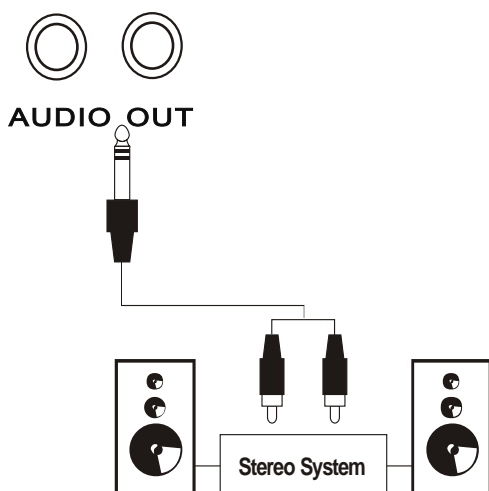

This interface could input signal into external amplifier, and connect with external stereo amplification system, forming an amplification system to amplify the sound. This function is designed for stage performance.

The difference with earphone is: the sound from this output is the primary sound that has not been processed, while the sound from earphone is processed.

■ Using Headphones

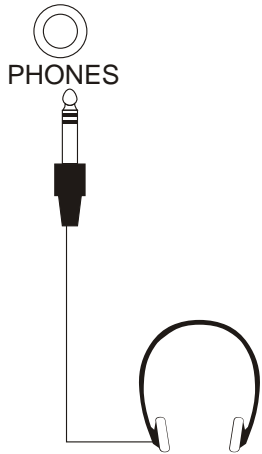

You can connect a set of stereo headphone to the PHONES jack. While such connection is made, you could only hear the sound through the earphone. Thus, you could practise and play without disturbing others.

■ Using a Sustain Pedal

This feature lets you use an optional Sustain pedal to sustain the sound of the voices. Press and hold down the pedal as you play the keyboard to sustain the sound.

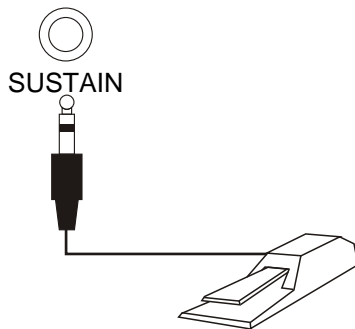

⚠ CAUTION

Do not press the sustain pedal while connecting the pedal to the terminal or turning on the power supply. Otherwise, it changes the recognized polarity of the pedal, resulting in reversed sustain pedal operation. To bring the reversed polarity normal, just turn off the power, and follow the proper procedure.

■ MIDI INPUT / OUTPUT

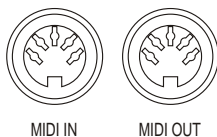

MIDI IN could be used to receive the MIDI data from the outside equipment connected.

MIDI OUT could send the MIDI Data of this instrument.

PLAYING THE PIANO

STARTING TO PLAY THE PIANO

First of all, turn on the power and set the volume. That is, push the POWER switch to ON and set the [MASTER VOLUME] dial to a suitable place. Every time you turn on the piano, it will automatically call up acoustic grand piano voice and 8-beat Style mode.

DEMO SONGS

There are all together 22 demonstration songs in this instrument, which thoroughly display its excellent quality in the tone and melody. You can get a general idea of this instrument through them.

■ Playing all demo songs

Press the [DEMO] button, and all the demonstration songs would be performed in order.

■ Playing a single selected demo song

After pressing the [DEMO] button, you could use [+ / YES] and [- / NO] to select the appropriate number of the desired song during playback.

NOTE:

You can still play on the keyboard while the demon song is being played, but if the sound overpasses the maximum data, it might not be voiced.

VOICE

In this instrument, there are 163 voices, including 25 Chinese voices, and 128 GM voices and 10 percussion groups.

■ Selecting a Voice

- ① Press [FUNCTION] button to enter VOICE function mode.
- ② Press [+ / YES] and [- / NO] buttons to choose the desired voice.

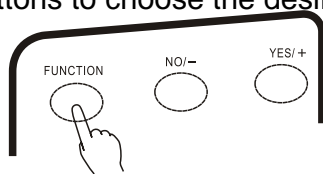

DUAL VOICE

This function allows you to play two voices at the same time.

- ① Follow the previous Selecting a Voice process to choose the first voice.
- ② Press the [DUAL] button to enter into Dual Voice mode. The name of the second voice will appear in the LCD;
- ③ Follow the previous Selecting a Voice process again to choose the second voice;
- ④ Press the [DUAL] button to stop Dual Voice function.

NOTE:

- In Dual Voice mode, if you press the keyboard, it may sound differently or like two voices mixed together. If you press this button right after you turn on this instrument, stringed instruments ensemble 1 would be automatically set as defaulted second voice.
- In this mode, you cannot choose the first voice, so you ought to settle the first voice before entering into this mode.

■ Balancing the Dual Voice

You should balance the volume of each voice by yourself.

- ① Press the [FUNCTION] button until it shows "Second Voice Volume" in the LCD.
- ② Press [+ / YES] and [- / NO] to adjust the second voice volume, ranging from 0 to 127.

NOTE:

By pressing [+ / YES] and [- / NO] at the same time, the volumes would return to the primary setting.

CONTROL AND EFFECT

This digital piano offers you various types of effects. You can freely choose your favourite one.

The Usage of Function buttons

■ Press each button once to choose different function

1. VOICE 2. STYLE MODE 3. DEMO SONG 4. CLOSE VOICE PART (for demo songs)
5. HARMONY 6. CHORUS 7. TRANSPOSE 8. TUNING 9. DUAL BALANCE 10. METRONOME

■ Stop certain function or return to the primary setting by pressing [+ / YES] and [- / NO] at the same time.

Withdraw from the Function MENU.

■ Press the [FUNCTION] button for 2 seconds to withdraw from the Function MENU.

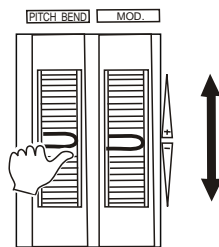

■ Pitchbend Wheel (the left wheel)

It is used to adjust the voice volume when playing this instrument, simulating the pitch bend of natural musical instruments. This enables certain voices (e.g. guitar) to be more vivid, and display different music styles.

Turn the roller with your left hand while your right hand is playing on the keyboard.

■ Modulation Wheel (the right wheel)

It is used to adjust the vibrato depth of the voice to enable the performance with richer content.

When the wheel is rolled to the bottom, the voice is normal. The higher it goes, the higher the vibrato brightness becomes.

NOTE:

- This wheel could do nothing to Auto Bass chord.
- The primary setting is +/- 200 diresis (2 semitones)

NOTE:

- When the piano is just switched on, wherever the modulation wheel locates, the voice remains to be normal. Roll the wheel again to restore its function.

■ Touch Response

This function could adjust the volume by controlling the strength of pressing the keyboard.

There are five touch types (1-5 sensibility scales) available by pressing the [TOUCH] button in the panel.

- ① Press the [TOUCH] button to enable this function, and the Touch icon appears in the LCD.
- ② Press the [TOUCH] button for at least 3 seconds, and the name of the type appears in the LCD.
- ③ You can change the touch type by using [+ / YES] and [- / NO] buttons.

NOTE:

The keyboard will automatically call up touch response after you turn it on. Its default touch type is medium response.

■ Reverb

This function is to add reverberation effect to the voices, which can create live effect and sound as if you were performing in a small room or a concert. A total of eight different Reverb types simulating various different performance environments are available. Press the [REVERB] button to shift this mode.

- ① Press the [REVERB] button for at least 3 seconds to enable this function, and there appears the Reverb icon in the LCD.
- ② You can change the reverberation type by using [+ / YES] and [- / NO] buttons.

NOTE:

This instrument will automatically call up Reverberation On mode after you turn it on.

■ Chorus

It is to add chorus effect to the voices. There are 8 different types available.

- ① Press the [FUNCTION] button to choose this function, and the Chorus icon appears in the LCD.
- ② You can close this function and change the chord type by using [+ / YES] and [- / NO] buttons.

NOTE:

The Reverb setting can be adjusted over a range from 0 to 127. This instrument will automatically turn to Chorus On mode after you turn it on.

■ Tuning

This function determines the fine pitch setting of both the main voice and the bass/chord accompaniment of the selected style. It also determines the pitch of the songs. This allows you to accurately match the tuning with that of other instruments without changing your fingering. The Tuning setting can be adjusted over a range of +/- 100 (approx. +/- 1 semitone).

- ① Press the [FUNCTION] button to select this function, and the Tune icon appears in the LCD.
- ② You can change the tuning by using [+ / YES] and [- / NO] buttons.

NOTE:

• By pressing [+ / YES] and [- / NO] at the same time, the tuning would return to its primary setting.

■ Transpose

This function determines the key of both the main voice and the bass/chord accompaniment of the selected style. It also determines the pitch of the songs. This allows you to easily match the pitch of this instrument to other instruments or singers, or play in a different key without changing your fingering. The transpose settings can be adjusted over a range of +/-12 semitones(+/-1 octave).

- ① Press the [FUNCTION] button to select this function, and the Transpose icon appears in the LCD.
- ② You can adjust the range of transpose by using [+ / YES] and [- / NO] buttons.

■ Harmony

The Harmony section features a variety of performance effects that enhance the melodies you play when using the accompaniment styles . A total of twenty-six Harmony types are available.

Tremolo, Trill and Echo effects can be used even if accompaniment is off. There are five different Harmony Types that automatically create harmony parts(for notes played in the upper section of the keyboard) to match the accompaniment chords.

- ① Press the [FUNCTION] button to select this function. When “Harmony Disabled” appears in the LCD, it means this function is closed.
- ② Press [+ / Yes] to enter into harmony mode.
- ③ You can chose your desired harmony type by using [+ / YES] and [- / NO] buttons.

NOTE:

- By pressing [+ / YES] and [- / NO] at the same time, the mode would return to the primary setting. A new mode is only valid to the notes played after this new mode is set.
 - This function is to change the places of the notes, in order to display the melody and accompaniment for the present voice and accompaniment style. But it has no effect on keyboard percussion music.
-

NOTE:

- For the first ten Harmony Types(Duet, Octave, Tremolo 1/4, Tremolo 1/6, Tremolo 1/8, Tremolo 1/12, Echo 1/4, Echo 1/6, Echo 1/8, Echo 1/12), chords must be played in the Accompaniment section of the keyboard.
 - The harmony voice will change its pitch to match the chord you are playing.
 - The speed of the Tremolo, Trill and Echo effects depends on the Tempo setting.
 - Each voice has its own independent Harmony setting.
-

AUTO ACCOMPANIMENT

ACCOMPANIMENT STYLE

This instrument provides dynamic rhymes and accompaniment patterns, as well as voice settings appropriate for each pattern for various popular music styles.

A total of 100 kinds of different accompaniment styles are available, in two different categories Group A and Group B. All leading styles are printed on the panel. At the upper part of each style button are styles of Group A and lower part Group B. Each style is made up of separate “sections” : Intro, Main A / Auto Fill-in, Main B / Auto Fill-in and Ending, letting you call up accompaniment sections as you perform. The auto accompaniment features that are built into the rhythms add the excitement of instrumental backing to your performance, letting you control the accompaniment by the chords you play. Auto accompaniment effectively splits the keyboard into two sections: the upper is used for playing a melody line, and the lower (set by default to keys F#2 and lower) is for the auto accompaniment function.

■ Selecting a Style

- ① Press [FUNCTION] button to enter STYLE mode.
- ② Press [+ / YES] and [- / NO] buttons to choose the desired style.

NOTE:

- The name of the accompaniment style you choose will be shown in the LCD.

■ Variation

Each accompaniment style has its own variations. There are Variation A/B button on the panel.

■ Adjusting the Accompaniment Volume

Use the [▲] [▼] ACMPVOL buttons to adjust the accompaniment volume. The range of this adjustment is from 0 to 127.

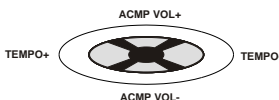

NOTE:

- By pressing [▲] [▼] buttons at the same time, the volume will return to its primary setting.

■ Adjusting the Accompaniment Tempo

Use the [▲] [▼] Tempo buttons to adjust the accompaniment tempo. The range of this adjustment is from 40 to 240.

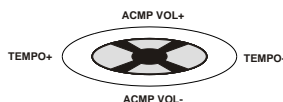

NOTE:

- By pressing [▲] [▼] buttons at the same time, the tempo will return to its primary setting.

■ Playing the Accompaniment

The panel buttons below function as accompaniment controls.

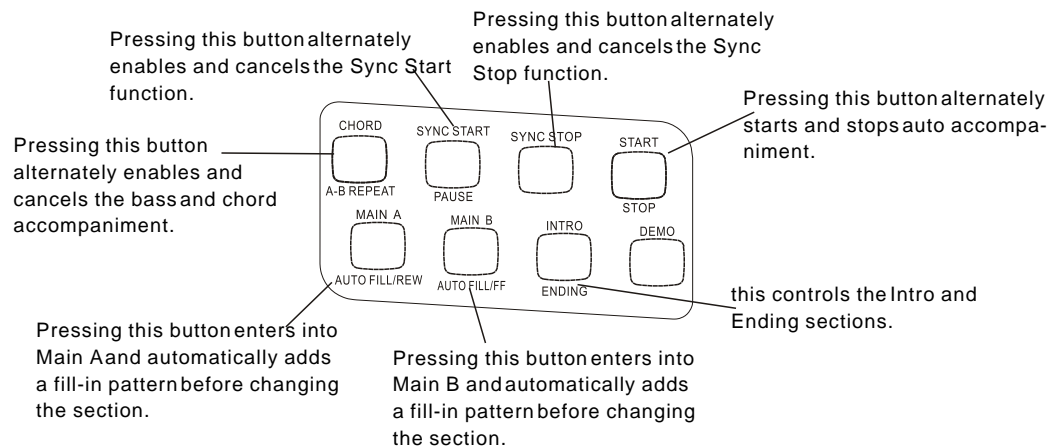

1. Turn on the auto accompaniment

Press the [CHORD] button to enable (turn on) the auto accompaniment.

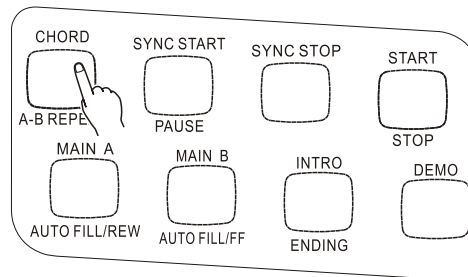

2. Start the accompaniment

You can do this in one of the following ways:

Press the [START / STOP] button

The rhythm starts playing immediately without bass and chord accompaniment. The currently selected Main A / B section will play.

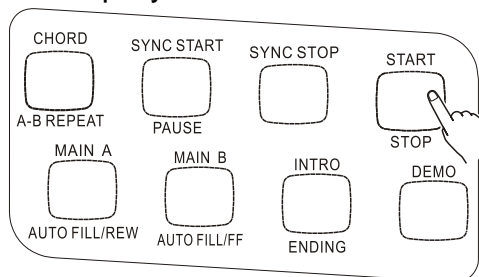

You can select the Main A / B section by pressing the appropriate button [MAIN A/B] before pressing the [START / STOP] button. (The display briefly shows the letter of the selected section: "MAIN A" or "MAIN B".)

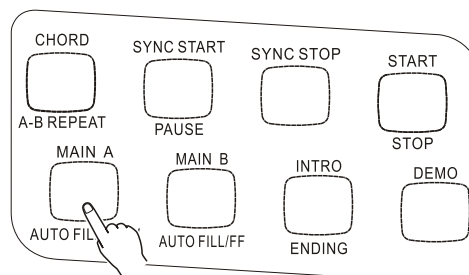

USING SYNC START

This instrument has Sync Start function that allows you to start the accompaniment and rhythm by simply pressing a key on the keyboard. To enable this function, first press the [SYNC START] button, (the beat marks all flash to indicate Sync Start stand-by), then press any key / chord on the keyboard. (When auto accompaniment is on, play a key or chord in the

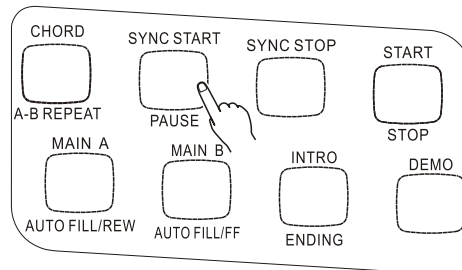

Starting with an Intro section.

Each style has two or four-measure Intro sections. When used with auto accompaniment, many of the Intro sections also include special chord changes and embellishment to enhance your performance.

To Start with an Intro section.

1). Press [MAIN /AUTO FILL] buttons to select which section (A or B) is to follow the Intro.

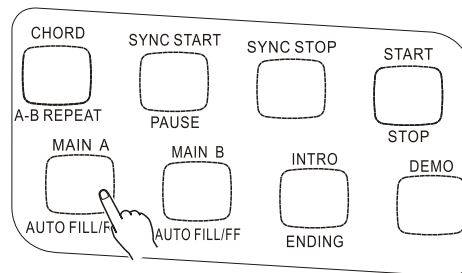

2) Press [Intro / Ending] button.

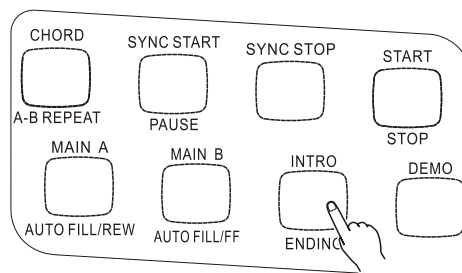

To actually start the Intro section and accompaniment, press the [START / STOP] button.

Using Sync Start with an Intro section

You can also use the Sync Start function with the special Intro section of the selected style.

To use Sync Start with an Intro section:

1). Press [MAIN / AUTO FILL] to choose which section (A / B) is to follow the Intro.

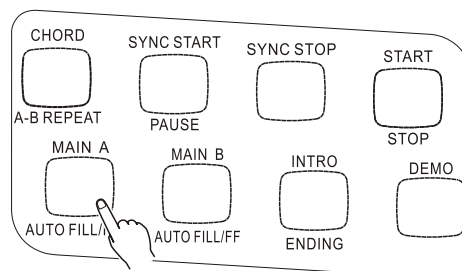

2). Press [INTRO / ENDING] button.

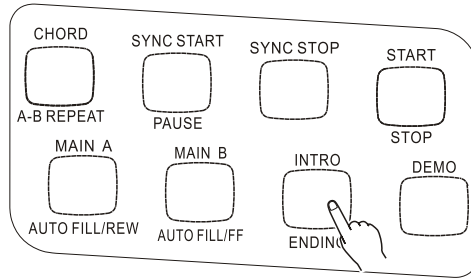

3). First press the [SYNC START] button to enable this function, and then start the Intro section and accompaniment by playing any key on the keyboard. (When auto accompaniment is on, play a key or chord in the auto accompaniment section of the keyboard.)

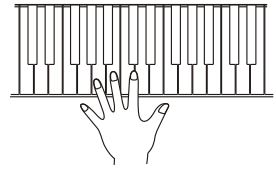
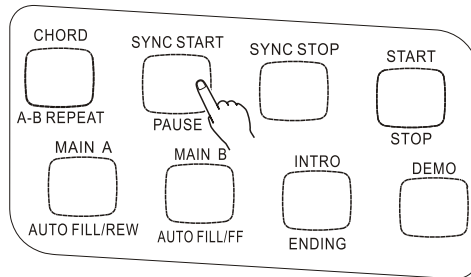

3. Using the Auto accompaniment function to change chords

Try playing a few successive chords with your left hand, and experience how the bass and chord accompaniments change with each chord you play.

4. Stop the accompaniment

There are three ways to stop the accompaniment.

■ Pressing the [START / STOP] button

The rhythm and accompaniment stops playing immediately.

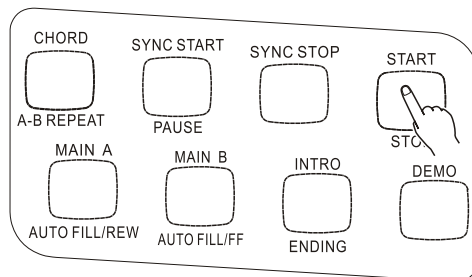

NOTE:

Chords played in the auto accompaniment section of the keyboard are also detected and played when the accompaniment is stopped. In fact, this gives you a "split keyboard," with bass and chords in the left hand and the normally selected voice in the right.

■ Using an Ending section

Press the [INTRO / ENDING] button, then the accompaniment stops after the Ending section is finished.

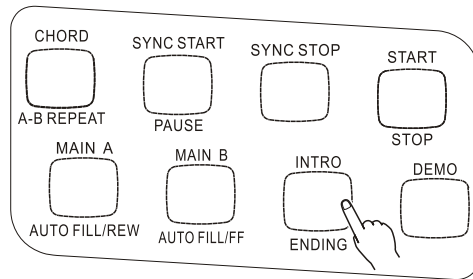

■ Pressing the [SYNC START] button

Doing this can immediately stop the accompaniment and automatically enables Sync Start, letting you re-start the accompaniment by simply playing a key or a chord in the auto accompaniment section of the keyboard.

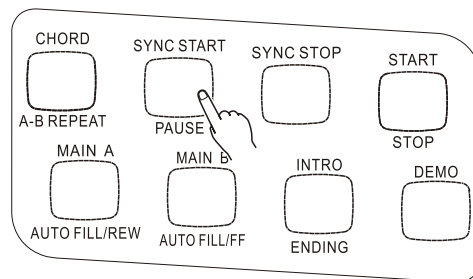

Changing the Split Point of the Accompaniment Track

Press the [CHORD] button for 2-4 seconds until in the LCD appears “Select the Accompaniment Track Split Point” .

Then use [+ / YES] and [- / NO] buttons to change the split point you want.

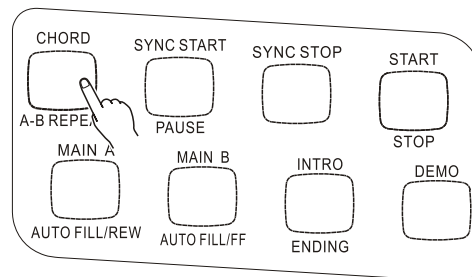

SYNC Stop

This convenient feature lets you stop / pause the auto accompaniment by releasing your fingers from the auto accompaniment section of the keyboard. Playing the chord again restarts the auto accompaniment. This is ideal for putting dynamic breaks in your performance for example, stopping the rhythm and accompaniment briefly while you play a melodic break or solo with your right hand.

1. Press the [AUTO ACMP] button.

To enable the accompaniment function

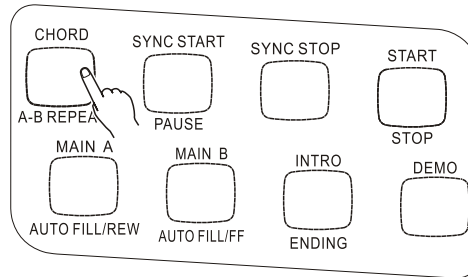

2. Press the [SYNC STOP] button.

Setting Sync Stop to on before starting the auto accompaniment automatically sets Sync Start on as well.

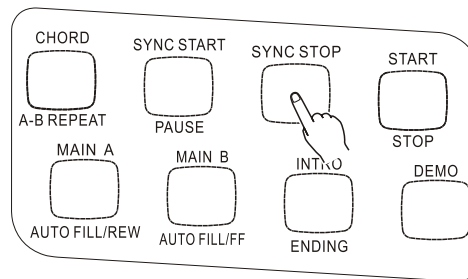

3. Play a chord on the keyboard (in the auto accompaniment section of the keyboard).

The auto accompaniment starts automatically as soon as you play a chord.

4. Stop the auto accompaniment by releasing the chord.

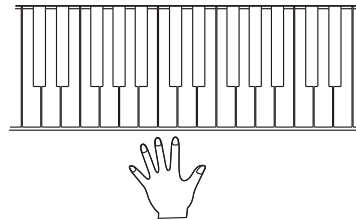

5. To start the auto accompaniment again, just play a chord.

6. To turn Sync Stop off, please press [SYNC STOP] button once more.

Pressing [START / STOP] button can completely stop the auto accompaniment.

ACCOMPANIMENT SECTIONS (MAIN A / B AND FILL-INS)

While the accompaniment is playing, you can add variation in the rhythm / accompaniment by pressing the [MAIN / AUTO FULL] button. This switches between the Main A and Main B sections, automatically playing a fill-in pattern to smoothly lead into the next section. For example, if the Main A section is currently playing, pressing this button automatically plays a fill-in pattern, followed by the Main B section. (See illustration on this page).

You can also select either the Main A or B section to start by pressing the [MAIN / AUTO FULL] buttons before starting the style.

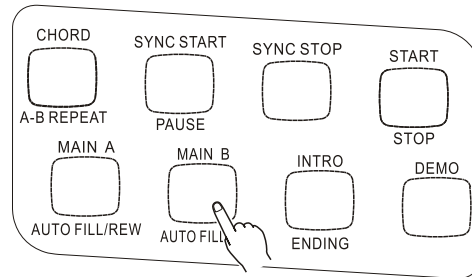

About the Fill-in Patterns

If you press the [MAIN / AUTO FILL] button before beat 4...

...A fill-in pattern plays immediately until the end of the measure...

And the Main A / B section plays here.

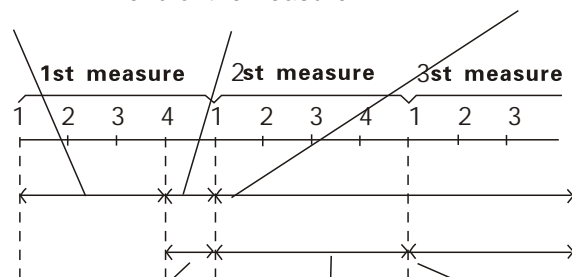

If you press the [MAIN / AUTO FILL] button here, after beat 4...

A fill-in pattern plays from here...

And the Main A / B section begins here...

USING AUTOACCOMPANIMENT—MULTIFINGERING

When it is set to on, the auto accompaniment function automatically generates bass and chord accompaniment for you to play along with, by using Multi Fingering operation. You can change the chords of the accompaniment by playing keys in the auto accompaniment section of the keyboard using either the “Single Finger” or “Fingered” method. With Single Finger you can simply play a one-, two- or three-finger chord indication (see Single Finger Chords below). The Fingered technique is that of conventionally playing all the notes of the chord. Whichever method you use, this instrument understands what chord you indicate and then automatically generates the accompaniment.





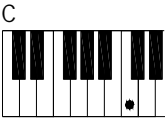
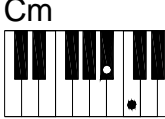
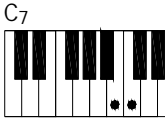
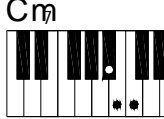







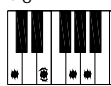
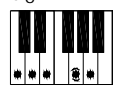
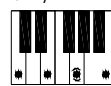
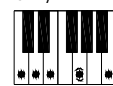

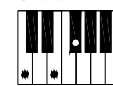



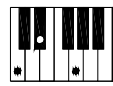
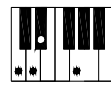

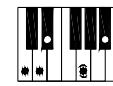
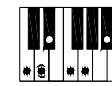

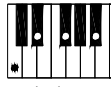
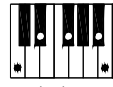
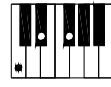
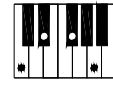

■ Single Finger Chords.

Chords that can be produced in Single Finger operation are major, minor, seventh and minor seventh. The illustration below shows how to produce the four chord types. (The key of C is used here as an example; other keys follow the same rules. For example, B^b 7 is played as B^b and A.)

 <p>C</p>	 <p>Cm</p>	 <p>C7</p>	 <p>Cm7</p>
<p>To play a major chord: press the root note of the chord.</p>	<p>To play a minor chord: press the root note together with the nearest black key to the left of it.</p>	<p>To play a seventh chord: press the root key together with the nearest white key to the left of it.</p>	<p>To play a minor seventh chord: press the root key together with the nearest white and black keys. (three keys together)</p>

■ Fingered Chords.

Using the key of C as an example, the chart below shows the types of chords that can be recognized in the Fingered mode.

Example for C chords								
								
								
								
								

*Notes enclosed in parenthesis are optional; The chords will be recognized without them.

Chord Name (abr.)	Common Voicing	Chord (C)	Display
Major[M]	1-3-5	C	C
Add ninth[(9)]	1-2-3-5	C(9)	C(9)
Sixth[6]	1-(3)-5-6	C6	C6
Sixth add ninth[6(9)]	1-2-3-(5)-6	C6(9)	C6(9)
Major seventh[M7]	1-3(5)-7or1-(3)-5-7	CM7	CM7
Major seventh ninth[M7(9)]	1-2-3(5)-7	CM9(9)	CM9(9)
Major seventh sharp add eleventh[M7(#11)]	1-(2)-3-#4-5-7or 1-2-3-#4-(5)-7	CM7(#11)	CM7(#11)
Flatted fifth[(b5)]	1-3-b5	C(b5)	C(b5)
Major seventh flatted fifth[M7aug]	1-3-b5-7	CM7b5	CM7b5
Suspended fourth[sus4]	1-4-5	Csus4	Csus4
Augmented[aug]	1-3-#5	Caug	Caug
Major seventh augmented[M7aug]	1-(3)-#5-7	CM7aug	CM7aug
Minor[m]	1-b3-5	Cm	Cm
Minor add ninth[m(9)]	1-2-b3-5	Cm(9)	Cm(9)
Minor sixth[m(6)]	1-b3-5-6	Cm6	Cm6
Minor seventh[m(7)]	1-b3-(5)-b7	Cm7	Cm7
Minor seventh add ninth [m7(9)]	1-2-b3-(5)-b7	Cm7(9)	Cm7(9)
Minor seventh add eleventh[m7(11)]	1-(2)-b3-4-5-(b7)	Cm7(11)	Cm7(11)
Minor major seventh[mM7]	1-b3-(5)-7	CmM7	CmM7
Minor major seventh ninth[mM7(9)]	1-2-b3-(5)-7	CmM7(9)	CmM7(9)
Minor seventh flatted fifth[m7b5]	1-b3-b5-b7	Cm7b5	Cm7b5
Minor major flatted fifth[mM7b5]	1-b3-b5-7	CmM7b5	CmM7b5
Diminshed [dim]	1-b3-b5	Cdim	Cdim
Diminshed seventh[dim7]	1-b3-b5-6	Cdim7	Cdim7
seventh [7]	1-3-(1)-b7 m 1-(3)-5-b7	C7	C7
seventh flatted ninth[7(b9)]	1-b2-3-(5)-b7	C7(b9)	C7(b9)
Seventh add flatted thirteenth[7(b13)]	1-3-5-b6-b7	C7(b13)	C7(b13)
Seventh ninth[7(9)]	1-2-3-(5)-b7	C7(9)	C7(9)
Seventh add sharp eleventh[7(#11)]	1-(2)-3#4-5-b7or 1-2-3-#4-(5)-b7	C7#(11)	C7#(11)
Seventh add thirtesnth[7(13)]	I-3-(5)-6-b7	C7(13)	C7(13)
Seventh sharp ninth[7(#9)]	I-#2-3-(5)-b7	C7(#9)	C7(#9)
Seventh flatted fifth[7b5]	I-3-b5-b7	C7b5	C7b5
Seventh augmented[7aug]	I-3-#5-b7	C7aug	C7aug
Seventh suspended[7sus4]	1-4-(5)-b7	C7sus4	C7sus4
One plus two plus five[1+2+5]	1-2-5	C1+2+5	C

NOTE:

-
- Notes in parentheses can be omitted.
 - Playing two same root keys in the adjacent octaves produces accompaniment based only on the root.
 - A perfect fifth (1+5) produces accompaniment based only on the root and fifth which can be used with both major and minor chords.
 - The chord fingerings listed are all in “root” position, but other inversions can be used with the following exceptions: m7, m7 b 5, 6, m6, sus4, aug, dim7, 7 b 5, 6(9), 1+2+5.
 - Inversion of the 7sus4 and m7(11) chords are not recognized if the notes shown in parentheses are omitted.
 - The auto accompaniment will sometimes not change when related chords are played in sequence (e.g. some minor chords followed by the minor seventh).
 - Two-note fingerings will produce a chord based on the previously played chord.
-

PERCUSSION

By applying percussion function, you can give a vivid performance as if you were playing a drum or some other percussion instruments. This keyboard can produce 61 different kinds of percussion music, and 18 traditional Chinese percussions.

1. Press [FUNCTION] button to voice section.
2. Press [-/NO] button to reach No.163 to 154 percussions.
3. By playing on the keyboard you can get the percussion music you want. On each key there is a certain icon standing for a corresponding percussion.
4. Pressing any other voice button you can close this percussion function.

NOTE:

When the Percussion function is on, you cannot change the present melody. Moreover, if you choose a certain voice after the percussion function is on, this function will be automatically cancelled. When the auto undertone function is on, the 19 lowest undertone keys (C1 to F2) cannot be applied to percussion music.

SONG MEMORY

To memorize songs is in terms of digitals saving your own performance (5 melody voice parts) and the accompaniment (chord voice part) together as a song, in case sometimes you want to repeat it again. This instrument can memory at most 5 songs. Song Memory consists of 8 control buttons: [SONG NO.] to choose the song, [SAVE] to do the preparation, [MELODY 1-5] to choose the melody voice part, [CHORD / CLEAR] to select the chord and musical track and as well as clear the saved songs.

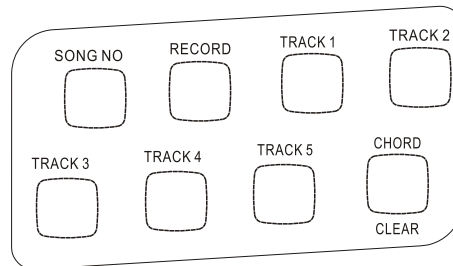

As a matter of fact, this function provides with 5 musical tracks available for saving the melody (Melodies in each track can choose different kinds of voices and percussions) and one special track to save the accompaniment (using Style mode or auto bass chord function). Please save the songs with the methods below:

- Save any melody track or chord track. (Single track record)
- When the auto bass chord function is on, save the melody track and chord track together. (Double tracks record)

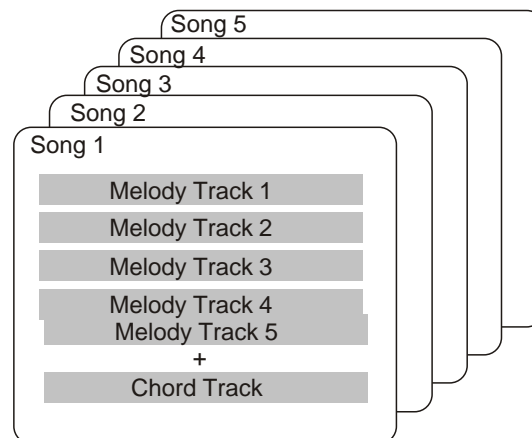

NOTE:

There's no special difference between single-track recording and double-track recording. Even when you record the melody and chord performance by double-track recording, this instrument can automatically separate it into melody track and chord track according to your performance. Thus, you can re-record a certain track (or correct an error) after double-track recording.

In addition, each track can save what stated below

- Melody1-5: the melody played on the keyboard, voice, dual on/off (and the choice of the second voice), dual balance, reverb on/off, sustain on/off, pitch bend roller, touch response on/off, percussion, chord on/off (with the parameters you've set), transpose on/off (with the parameters you've set).

- Chord: the chord played on the keyboard (regardless of auto bass chord mode), Style choice, accompaniment proceeding (intro, fill-in, ending, A/B variation on/off, change of accompaniment volume).

NOTE:

Both the beginning tempo and the tempo change in the recording will be recorded as parts of the song.

SONG RECORDING

This instrument features powerful and easy-to-use song recording features that let you record your keyboard performances using up to six independent tracks (including one track for accompaniment) for creating your own complete, full orchestrated compositions. You can record and save up to five User songs.

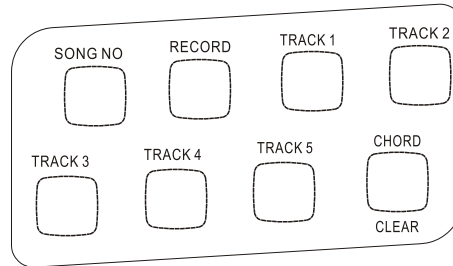

Song recording is similar to using a tape recorder, whatever you play on the keyboard is recorded in real time as you play it. Also, when you record subsequent parts to other tracks, you can hear the previously recorded parts as you record new ones.

RECORDING A USER SONG

The data that can be recorded to normal(melody) tracks are listed as below:

- Note on/off
- Touch Type
- Voice Number
- Reverb Type
- Chorus Type *
- Velocity *
- Sustain
- Tempo, Time Signature (if it is not in the chord track)

The data recorded into Chord track:

- Style number *
- Chord changes and timing
- Changing Section (Intro, Main A/ B, Fill-in, Ending, etc.)
- Reverb scope
- Accompaniment Volume *
- Tempo, Time Signature

* Those settings can be recorded only once when the music begins, while others can be changed during the music.

1. To make all desired settings.

Before you actually start recording, you'll need to make various settings for the song such as selecting a style, setting the Tempo, and selecting a voice.

If desired, also make other settings. Refer to the list above for settings that can be recorded to a song.

2. To select a User song number for recording.

Press [SONG NO] button, and use [+ / Yes] or [- / No] button to choose song number you want for recording.

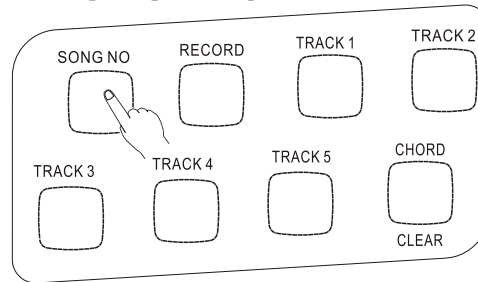

3. To chose the recorded track number.

While holding down the [RECORD] button, press the appropriate Song Memory button. Melody track 1 to 5 can only be chosen once at a time and the display light of time signature flicks. The track number temporarily appears in the LCD before it recovers to its the previous display.

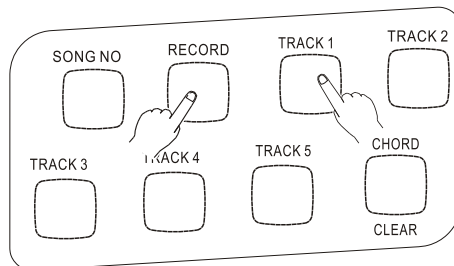

NOTE:

Keep in mind that all recording operations replace all the information recorded before. In other words, if you record to a track that already has recorded data, all previous data in the track will be erased and replaced by the newly recorded data.

■Recording to the Chord Track

A special chord track is prepared for recording accompaniment data. This is automatically recorded to the Chord track(track A). Selecting the chord track will also automatically turns on the accompaniment.

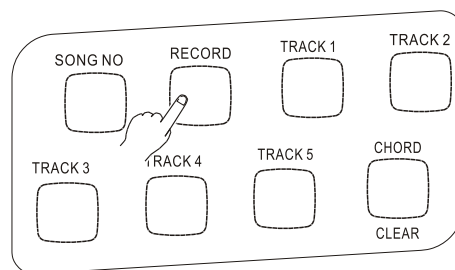

■Recording to a Melody Track (1 to 5)

Five independent melody tracks are prepared to record your keyboard performance. Usually, you'll want to record these after you've recorded the Chord track. But you can also simultaneously record Chord track and one Melody track.

Muting Tracks During Playback

While the recording is enabled, you can selectively mute different tracks. This is useful for when you want to clearly hear certain tracks, and not others, during recording. Muting can also be done “on the fly” during playback. To use muting, press the corresponding SONG MEMORY button, repeatedly if necessary, until the desired track number in the display is off.

Each press of a SONG MEMORY button (when playback is stopped) cycles through the following settings.

4. To start recording.

When the beat marks and track number start flashing, you can start recording simply by playing the keyboard (or by pressing the [START/STOP] button).

When Sync start is on, play the first chord of the song in the auto accompaniment section of the keyboard. The accompaniment starts automatically and you can continue recording, playing other chords in time with the accompaniment.

NOTE.

If the previous accompaniment track or melody track is on, it can be monitored during the recording. If no of that track is needed, you can press its button again to close it. The screen will show the current track number in the “state” column.

5. Stop recording:

After you've finished playing the part, press the [START/ STOP] button or [RECORD] button to stop recording.

6. Record to other tracks as desired.

To do this, simply repeat step 3 to 5 above. Make sure that when you press the [SONG MEMORY] button corresponding to the desired track, the track number in the display flashes.

7. Listen to newly recorded song:

To play back the song from the beginning, simply press the [START/STOP] button again. Playback stops when the [START/STOP] button is pressed again.

NOTE.

If no power is provided, the recorded data can only be reserved for one week or more. Important data should be stored in other equipment through the function of batch output.

SONG CLEAR

The Song Clear operation completely erases all the recorded data on all tracks of a selected User song. Use this operation only when you are sure you want to erase a song and record a new one. To erase an individual track of a song while leaving the other tracks intact, use the Track Clear operation.

1. Select the desired song.

Press the [SONG NO] button, and then use [+ / YES] or [- / NO] button to select the desired song (between No.1 to No.5).

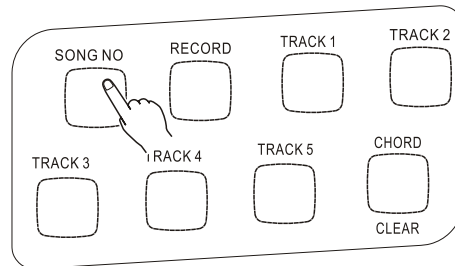

2. While holding down the [CHORD/CLEAR] button, press [SONG NO] button.

All track indications in the LCD flash, indicating that all tracks are to be erased.

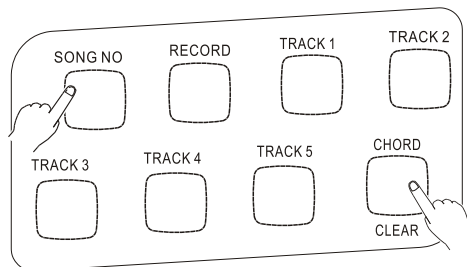

3. Press [+ / YES] button.

4. At the "Sure?" prompt, press the [+ / yes] button, or press the [- / NO] button to abort.

Press the [+ / YES] button is to clear the desired song. LCD shows "Sure?"

Again press the [+ / YES] button and LCD says, "Cleared" .

Press button [- / NO] is to cancel the operation.

TRACKS CLEAR

The Track Clear operation is to completely erase all the recorded data on a selected track of a selected User song, leaving the other tracks intact. Use this operation only when you are sure to clear a track and record a new one. To erase the data of an entire song, use the Song Clear operation.

1. Select the desired song.

Press the [SONG NO] button, and then use the numeric keypad or press [+ / Yes] or [- / No] button to select the desired song (No.1 to No.5).

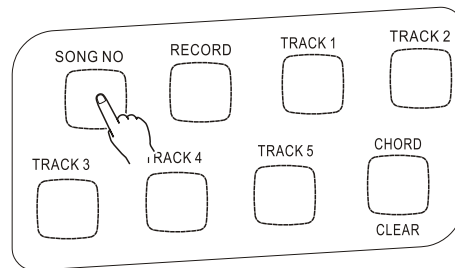

2. Press and hold down the button corresponding to the track to be erased.

Press and hold down the appropriate [SONG MEMORY] button ([1]-[5], [A]) for at least one second.

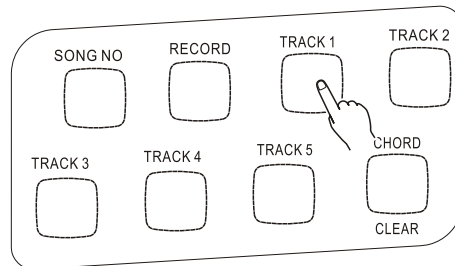

3. Press the [+ / YES] button.

4. At the "Sure?" prompt, press the [+ / YES] button, or press the [- / NO] button to abort.

Pressing the [+ / YES] button is to clear the desired track. LCD shows "sure?"

Again press the [+ / YES] button and in the LCD says, "Cleared".

Pressing button [- / NO] is to cancel the operation

PLAYING A SONG

This button is the panel button of song control functions. Its usage covers your saved User songs and the demo songs.

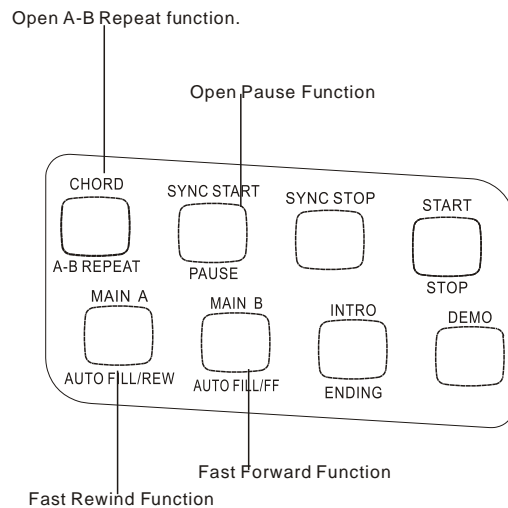

About Song track:

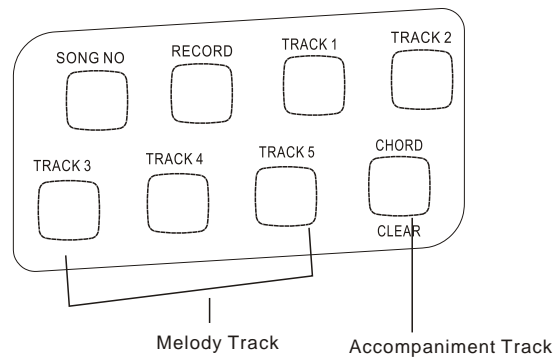

1. Start the desired song.

Press [PLAY/ STOP] button. As the song is being repeatedly played, the measure number and chords are shown in the LCD.

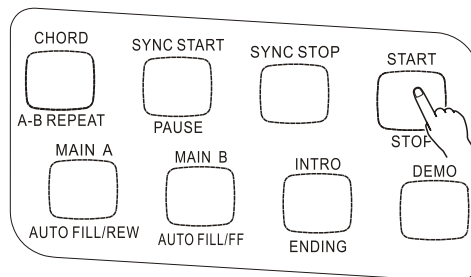

2. Stop the song playback.

Press [START / STOP] button. If the playback is repeated by using the button [START/ STOP], the song will automatically stop.

A—B REPEAT

This convenient A-B Repeat function is an ideal aid for practising and learning. It allows you to specify a phrase of a song (from A point to B point), and repeat it while yourself practice or play along with it.

1. Set point A (the start point) while playing a song.

During the playback, press the [A-B REPEAT] button once, at the beginning point to be repeated.

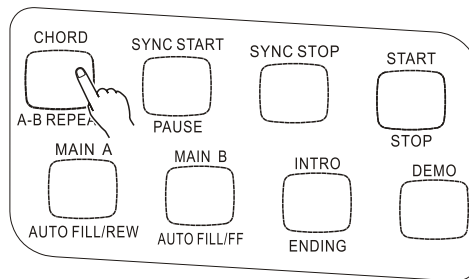

2. Set point B (the end point).

While the song continues playing, press the [A-B REPEAT] button once again, at the place you want it to stop repeating. Thus, the selected phrase repeats indefinitely until stopped.

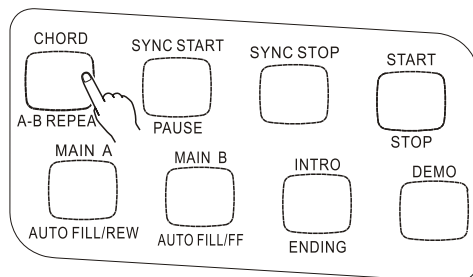

NOTE:

- The A and B points can only be specified at the beginning of a measure (beat 1), and not at any point in the middle of a measure.
- To set the A point to the beginning of a song, press the [A-B REPEAT] button before starting playback.

3. Pause or stop playback as needed.

Just use [PAUSE] or [START / STOP] button. Stopping playback does not cancel the set A / B point or the A-B Repeat function.

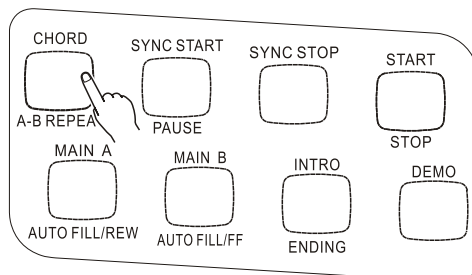

4. Turn off the A-B Repeat function
Press the [A-B REPEAT] button

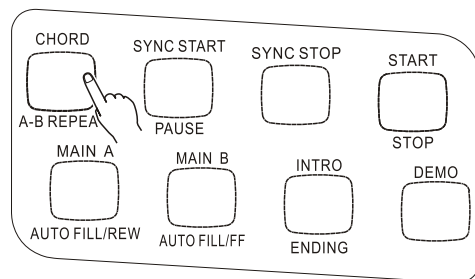

HINT:

- If you are repeat practising a particularly difficult section, try slowing down the tempo to an appropriate speed to make it easier to play and master the part. You may also want to slow down the Tempo while setting the A/ B point, this makes it easier to accurately set the points.
- You can also set the A-B Repeat function while the song is paused or stopped. Simply use [F F] / [REW] button to select the measures you want, then press the [A-B REPEAT] button for each point, and finally just start playback.

REGISTRATION MEMORY

REGISTRATION MEMORY

By applying this convenient function, you can save at most 32 panel settings (8 groups and 4 in each group). And you can recall any setting at any moment if you want.

Each panel consists parameters below:

- Voice Number (as well as Group A / B choice);
- Dual (Second voice choice and Dual balance)
- Chorus on/off, type
- Reverb Type
- Transpose setting
- Style Number (as well as Group A / B choice)
- Tempo setting
- Tuning
- Harmony on / off and its type
- Pitchben Range
- Accompaniment volume

RECORDING A REGISTRATION MEMORY PRESET

1. Press the [BANK] button then there appears “BANK” in the LCD. Using [+ / YES] and [- / NO] buttons to choose the group (Group 1--8)

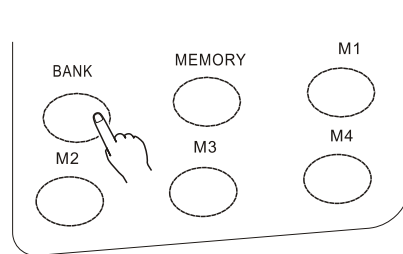

2. Keep the [MEMORY] button pressed and then press any button of Save and Register buttons (1 to 4). In LCD, there appears “Registration Memory”, and as well as the corresponding number. The new setting will be saved to corresponding place in the memory. The register number will be shown in the first line of the screen for a short time and then the original display recovers.

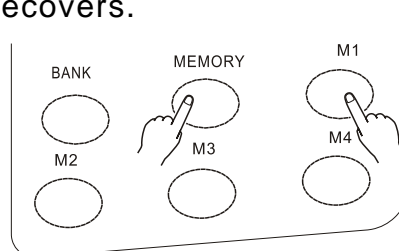

RECALLING A REGISTRATION MEMORY PRESET

1. First press [BANK] button, and then use [+ / YES] and [- / NO] to select the register number (from 1 to 8); if you do not select, it means to use the present memory bank.

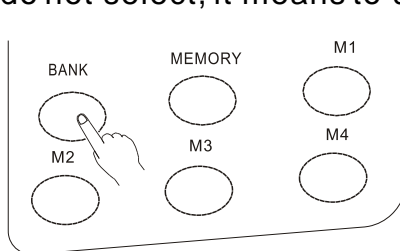

2. Then press the register you want, and it will be recalled. The register number will be shown in the first line of the screen for a short time and then the original display recovers.

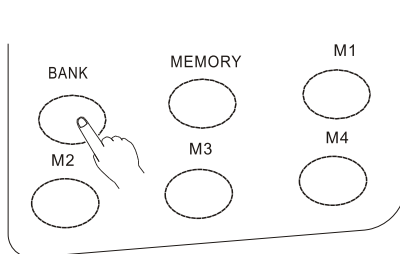

NOTE.

- If no power is provided, the recorded data can only be reserved for one week or more. Important data should be stored in other equipment through the function of batch output.
- If do not select the memory bank first, then it will automatically use the present bank.

MIDI FUNCTIONS

This instrument is MIDI-compatible, featuring MIDI IN and MIDI OUT terminals and providing a variety of MIDI-related controls. By using MIDI functions, you can expand your musical possibilities.

WHAT IS MIDI?

No doubt you have heard the terms----acoustic instruments and digital instruments. In the world today, these are the two main categories of musical instruments. Let's consider an acoustic piano and a classical guitar as representative acoustic instruments. They are easy to understand. With the piano, you strike a key, and a hammer inside hits some strings and plays a note. With guitars, you directly pluck a string and the note sounds. But how do digital instruments go about playing a note?

Acoustic guitar note production

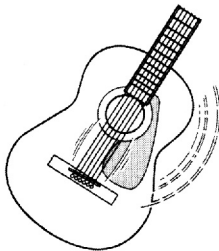

Pluck a string and the body resonates the sound.

Digital instrument note production

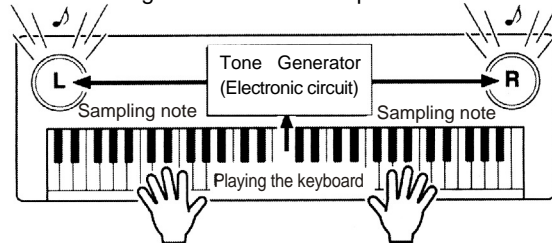

Based on playing information from the keyboard, a sampling note stored in the tone generator is played through the speakers.

As shown in the pictures above, in digital instruments, the sample notes (reserved notes) stored in the tone generator section (electronic circuit) can be played when the information on the keyboard is collected. Then what is the information on the keyboard? For instance, if you use this instrument to play a C quarter note, unlike an acoustic instrument that puts out a resonated note, it puts out information from the keyboard such as “with what voice” , “wth which key” , “about how strong” , and “when was it pressed” and “when was it released” . All the information will be converted to a number value and sent to the tone generator. Based on these data, the music source will adopt stored sample note and play it.

MIDI FUNCTION

MIDI is the abbreviation of musical instruments digital interface. It allows the digital instruments to communicate with each other, by sending and receiving compatible notes, control change and program change, and as well as other types of MIDI data and information.

MIDI is an international standard. It enables all the instruments to connect together, and allows them to control each other and exchange data. That is, it makes all the instruments a system, and greatly enlarges its function.

This instrument can control MIDI device by transmitting note-related data and various types of controller data, and also can be controlled by outside MIDI information, which can automatically decide the music source mode, and choose MIDI track, voice and effect, and change the parameter and as well as perform the appointed voice.

■MIDI Interface

MIDI IN is to receive outside data from other MIDI devices like sequencer in order to control this instrument; MIDI OUT is to send MIDI data (like the note and touch data) from this instrument.

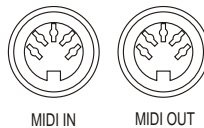

■REMOTE PASSAGE

To set the MIDI passage to receive outside keyboard data, please select 01-16. The outside keyboard must set the source passage from which the data is sent and its MIDI OUT connects this keyboard's MIDI IN by the MIDI cable. When set is OFF, this keyboard will receive from all the 16 tracks. Pressing [-/NO] and [+ /YES] buttons at the same time can retune to the original setting (OFF).

■KEYBOARD OUTPUT

To determine whether the data output from the MIDI OUT.



Never use MIDI cables longer than about 15 meters. Cables longer than this can pick up noise which can cause data errors.

CONNECT TO A PERSONAL COMPUTER

By connecting MIDI terminals to a personal computer, you can have access to a wide variety of music software.

- When using a MIDI interface device installed in the personal computer, connect the MIDI terminals of the personal computer and this instrument.

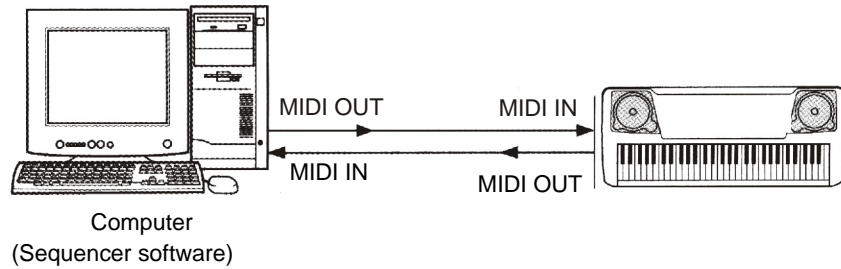

- When using a MIDI interface with a Macintosh series computer, please connect the RS-422 terminal of the computer (Modem port or printer terminal) to the MIDI interface, as shown in the diagram below.

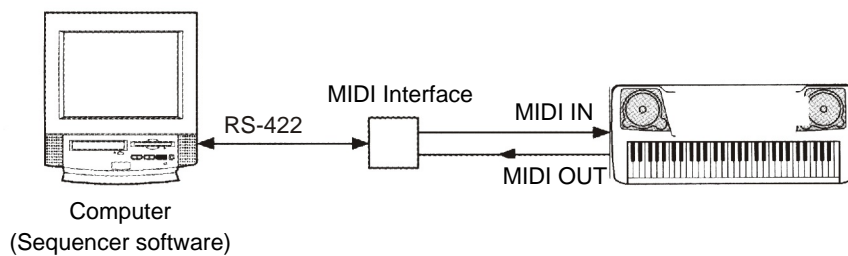

- When connecting to a computer with a USB interface, just use MIDI interface: first use a standard USB cable to connect Ux16 interface to the computer, and then connect this instrument to UX16 interface correctly.

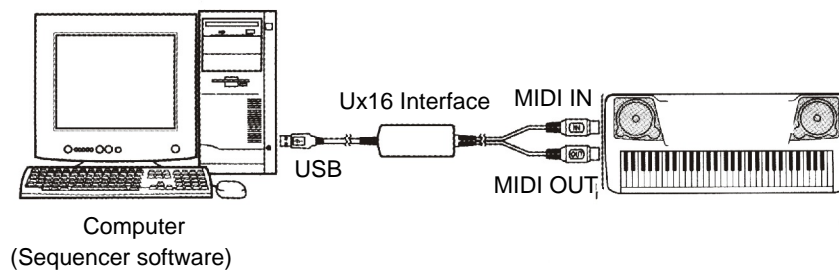

VOICE LIST

VOICE LIST

This instrument has 64-note maximum polyphony. This means that it can play a maximum of up to 64 notes at once, regardless of what functions are used. Auto Accompaniment uses a number of the available notes, so when Auto Accompaniment is used the total number of available notes for playing on the keyboard is correspondingly reduced. The same applies to the Split Voice and Song functions.

Caution: The Voice List includes MIDI program change numbers for each voice. Use these program change numbers when playing this instrument via MIDI from an external device.

Voice No	MIDI No	Name of Voice	中文名称
PIANO 钢琴			
01	0	ACOUSTIC GRAND PIANO	原声大钢琴
02	1	BRIGHT ACOUSTIC PIANO	亮原声钢琴
03	2	ELECTRIC GRAND PIANO	电子大钢琴
04	3	HONKY-TONK PIANO	酒吧钢琴
05	4	ELECTRIC PIANO1	电钢琴1
06	5	ELECTRIC PIANO2	电钢琴2
07	6	HARP	拨弦古钢琴
08	7	CLAV1	击弦古钢琴
CHROMATIC PERCUSSION 打击乐器			
09	8	CELESTA	钢片琴
10	9	GLOCKENSPIEL	钟琴
11	10	MUSIC BOX	音乐盒
12	11	VIBRAPHONE	振琴
13	12	MARINBA	马林巴
14	13	XYLOPHONE	木琴
15	14	TUBULAR BELLS	管钟
16	15	DULCIMER	洋琴
ORGAN 风琴			
17	16	DRAWBAR ORGAN	卓芭风琴
18	17	PERCUSSIVE ORGAN	打击风琴
19	18	ROCK ORGAN	摇滚风琴
20	19	CHURCH ORGAN	教堂风琴
21	20	FEED ORGAN	簧片风琴
22	21	ACCORDION	手风琴
23	22	HARMONICA	口琴
24	23	TANGO ACCORDION	探戈手风琴
GUITAR 吉它			
25	24	ACOUSTIC GUITAR(NYLIN)	尼龙弦吉它
26	25	ACOUSTIC GUITAR(STEEL)	钢弦吉它
27	26	ELECTRNIC GUITAR(JAZZ)	爵士电吉它
28	27	ELECTRNIC GUITAR(CLEAN)	清音电吉它
29	28	ELECTRNIC GUITAR(MUTED)	弱音电吉它
30	29	OVERDRIVEN GUITAR	夸张吉它
31	30	DISTOTION GUITAR	失真吉它
32	31	GUITAR HARMONICS	吉它泛音
BASS 贝司			
33	32	ACOUSTIC BASS	古典贝司
34	33	ELECTRIC BASS(FINGER)	指弹电贝司
35	34	ELECTRIC BASS(PICK)	拨片电贝司
36	35	FRETLESS BASS	无品贝司
37	36	SLAP BASS1	打弦贝司1
38	37	SLAP BASS2	打弦贝司2
39	38	SYNTH BASS1	合成贝司1
40	39	SYNTH BASS2	合成贝司2

Voice No	MIDI NO	Name of Voice	中文名称
STRINGS 弦乐			
41	40	VOLIN	小提琴
42	41	VLOLA	中提琴
43	42	CELLO	大提琴
44	43	CONTRABASS	低音提琴
45	44	TREMOLO ATRINGS	震音弦乐
46	45	PIZZICATO STRINGS	拨奏弦乐
47	46	ORCHESTRAL HARP	竖琴
48	47	TIMPANI	定音鼓
RNSEMBLE 合奏			
49	48	STRINGS ENSEMBLE1	弦乐合奏1
50	49	STRINGS ENSEMBLE12	弦乐合奏2
51	50	SYNTH STRINGS1	合成弦乐1
52	51	SYNTH STRINGS2	合成弦乐2
53	52	CHOIR AAHS	唱音 啊
54	53	VOICE OOHS	人声 噢
55	54	SYNTH VOICE	合成人声
56	55	ORCHESTRA HIT	管弦乐齐奏
BRASS 铜管			
57	56	TRUMPET	小号
58	57	TROMBONE	长号
59	58	TUBA	大号
60	59	MUTED TRUMPET	弱音小号
61	60	FRENCH HORN	圆号
62	61	BRASS SECTION	铜管乐队
63	62	SYNTH BRASS1	合成铜管乐1
64	63	SYNTH BRASS2	合成铜管乐2
REED 簧管乐器			
65	64	SOPRANO SAX	高音萨克斯
66	65	ALTO SAX	中音萨克斯
67	66	TENOR SAX	次音萨克斯
68	67	BARTION SAX	低音萨克斯
69	68	OBOE	双簧管
70	69	ENGLISH HORN	英国管
71	70	BASSOON	巴松管
72	71	CLARINET	单簧管
PIPE 木管乐器			
73	72	PICCOLO	短笛
74	73	FLUTE	长笛
75	74	RECORDER	竖笛
76	75	PAN FLUTE	排箫
77	76	BLOWN BOTTLE	吹瓶
78	77	SHAKUHACHI	尺八
79	78	WHISTLE	口哨
80	79	OCARINA	奥卡利那笛

VOICE LIST

Voice No	MIDI No	Name of Voice	中文名称
SYNTH REED 合成管乐器			
81	80	LEAD1(WOUIARE)	方波管乐
82	81	LEAD2(SAWTIITH)	锯齿波管乐
83	82	LEAD3(CALLIOPE)	蒸汽琴管乐
84	83	LEAD4(CHIFF)	雪坊管乐
85	84	LEAD5(CHARANG)	沙朗管乐
86	85	LEAD6(VOICE)	人声管乐
87	86	LEAD7(FIFTH)	五度管乐
88	87	LEAD8(BASS+LEAD)	贝司管乐
SYNTH PAD合成背景音色			
89	88	PAD1(NEW AGE)	新世纪垫
90	89	PAD2(WARM)	温暖音色垫
91	90	PAD3(POLYSYNTH)	聚合成音色垫
92	91	PAD4(CHOIR)	唱诗垫
93	92	PAD5(BOWED)	弓弦音色垫
94	93	PAD6(METALLIC)	金属音色垫
95	94	PAD7(HALO)	环形音色垫
96	95	PAD8(SWEEP)	掠扫音色垫
SYNTH EFFECTS合成效果音色			
97	96	FX1(RAIN)	雨
98	97	FX2(SOUNDTRACK)	声轨
99	98	FX3(CRYSTAL)	水晶
100	99	FX4(ATMOSPHERE)	大气
101	100	FX5(BRIGHTNESS)	闪亮
102	101	FX6(GOBLINS)	小妖怪
103	102	FX7(ECHOES)	回声
104	103	FX8(SCO-FI)	科幻
ETHNIC民族乐器			
105	104	SITAR	西塔尔
106	105	BANJO	班卓琴
107	106	SHAMISEN	三弦
108	107	GUZHENG	古筝
109	108	KALIMBA	卡林巴
110	109	BAGPIPE	风笛
111	110	ERHU	二胡
112	111	SUONAI	唢呐
PERCUSSION打击乐器			
113	112	TINKLE BELL	响铃
114	113	AGOGO	啊果果
115	114	STEEL DRUMS	钢鼓
116	115	WOOBLOCK	盒梆
117	116	TAIKO DRUM	日本鼓
118	117	MELODIC TOM	旋律鼓
119	118	SYNTH DRUM	合成鼓
120	119	REVERSE CYMBAL	反钹

Voice No	MIDI No	Name of Voice	中文名称
SOUND EFFECT 效果音色			
121	120	FRET NOSE	弦马杂音
122	121	BREATH NOISE	呼吸音
123	122	SEASHORE	海滨
124	123	BIRD TWEET	小鸟叫声
125	124	TELEPHONE RING	电话铃
126	125	HELICOPTER	直升飞机
127	126	APPLAUSE	喝彩
128	127	GUNSHOT	枪声
FOLK民乐音色			
129	128	YUNLUO	云锣
130	129	GUANMEILANG	甘美郎
131	130	BIANMANG	编铙
132	131	YANGQIN	扬琴
133	132	LUSHENG	芦笙
134	133	PIBA	琵琶
135	134	LUOQIN	柳琴
136	135	YUQIN	月琴
137	136	DARUAN	大阮
138	137	ZHONGRUAN	中阮
139	138	GUOHU	高胡
140	139	ERHU	二胡
141	140	ZHONGHU	中胡
142	141	ERHUQUN1	二胡群1
143	142	ERHUQUN2	二胡群2
144	143	ZHONGHUQUN	中胡群
145	144	BANGDI	梆笛
146	145	KUNDI	昆笛
147	146	XIAO	箫
148	147	BANHU	板胡
149	148	XIPI	西皮
150	149	ZHUIHU	坠胡
151	150	SANXIAN	三弦
152	151	GUZHENG	古筝
153	152	GUOYINSUONA	高音唢呐
PERCUSSION打击乐			
154	153	STANDARD DRUMS	标准鼓组
155	154	CHINESE PERCUSSION	中国打击乐组
156	155	ROOM DRUMS	房间鼓组
157	156	ROCK DRUMS	摇滚鼓组
158	157	ELECTRIC DRUMS	电子鼓组
159	158	T 808 DRUMS	T808鼓组
160	159	JAZZ DRUMS	爵士鼓组
161	160	BRUSH KIT	刷子鼓组
162	161	CLASSIC DRUMS	古典鼓组
163	162	SFX KIT	效果鼓组

RHYTHM LIST

No	Name	中文名
8/16BEAT 8/16拍		
00	8BEAT-1	8拍1
01	8BEAT-2	8拍2
02	8BEAT-3	8拍3
03	16BEAT-1	16拍1
04	16BEAT-2	16拍2
05	16BEAT-3	16拍3
POP 流行乐		
06	POOPROCK	流行摇滚
07	FOLKROCK	民歌风摇滚
08	POPOLERO	流行波莱罗
09	POPWALTZ	流行华尔兹
10	SOULBALLAD	流行民谣
11	MOOTOWN	底特律节奏
DANCE 舞曲		
12	HOUSE	家庭舞曲
13	TECHNO-1	现代舞曲1
14	TECHNO-2	现代舞曲2
15	RAVE	拉布
16	DANCE-1	舞曲1
17	DANCE-2	舞曲2
18	DISCO-70S	70年代迪斯科
19	DISCO	迪斯科
20	MACARENA	马卡伦那
R&B 蓝调摇滚		
21	GOSPEL-1	黑人福音音乐1
22	GOSPEL-2	黑人福音音乐2
23	R&B-1	蓝调摇滚1
24	R&B-2	蓝调摇滚2
25	BLUES-1	布鲁斯1
26	BLUES-2	布鲁斯2
27	FUNK	早期爵士乐
ROCK 摇滚乐		
28	ROCK-60S	60年代摇滚
29	ROCK-70S	70年代摇滚
30	ROCK-80S	80年代摇滚
31	BALLROCK	舞会摇滚
32	SLOWROCK	慢摇滚
33	SLOWROCK6/8	慢摇滚6/8
ROCK&ROLL 快速摇滚乐		
34	ROCK&ROLL-1	快速摇滚1
35	ROCK&ROLL-2	快速摇滚2
36	SHUFFLE	滑曳摇滚
37	TWIST	扭扭舞
38	BOOGIE-1	布吉乐1
39	BOOGIE-2	布吉乐2
SWING/JA 摇摆舞/爵士		
40	SWING	摇摆舞
41	LOUNGE	悠闲爵士
42	DIXIE-1	新奥尔良爵士1
43	DIXIE-2	新奥尔良爵士2
44	JAZZBALLAD-1	舞会爵士乐1
45	JAZZBALLAD-2	舞会爵士乐2
46	JAZZWALTZ	爵士华尔兹
47	CHARLSTON	查尔斯顿舞
48	RAGTIME	早期爵士乐
COUNTRY 乡村音乐		

NO	Name	中文名
49	COUNTRY-1	乡村音乐1
50	COUNTRY-2	乡村音乐2
51	COUNTRYDANCE	乡村舞曲
52	COUNTRYROCK	乡村摇滚
53	COUNTRYWALTZ	乡村华尔兹
CARIBBEAN 加勒比音乐		
54	REGGAE-1	雷格1
55	REGGAE-2	雷格2
56	CARIBBEAN	加勒比节奏
LATIN-1 拉丁1		
57	BOSSA-1	波萨诺瓦1
58	BOSSA-2	波萨诺瓦2
59	SAMBA-1	桑巴1
60	SAMBA-2	桑巴2
61	RUMBA	伦巴
62	BEGUINE	贝津舞
63	CHACHA-1	恰恰1
64	CHACHA-2	恰恰2
LATIN-2 拉丁2		
65	SALSA	萨尔萨舞曲
66	CUMBIA	巴西舞曲
67	MERENQUE	美伦格舞
68	MAMBO	曼波舞曲
69	LATIN	拉丁舞曲
70	GIPSY	吉普赛舞
71	D.SAMBA	迪斯科桑巴
ORIENTAL 东方舞曲		
72	CINGENE	阿拉伯舞曲
73	MUS5/8	土耳其舞曲
74	ORIENTAL	东方舞曲
75	OYUNHAVA	小亚细亚舞曲
WORLD MUSIC 世界音乐		
76	SEVILLIANA	赛尔维利亚舞曲
77	HOLLYWOOD	好莱坞
78	SP.RUMBA	西班牙伦巴
79	SP.BOLERO	西班牙波莱多
80	SIRTAKI	希腊舞曲
81	BAROQUE	巴洛克
82	HAWAII	夏威夷舞曲
BALLROOM 交谊舞曲		
83	FOXTROT	狐步舞曲
84	QUICKSTEP	快步舞
85	SLOWFOX	慢狐步舞
86	TRAD.WALTZ	传统华尔兹
87	JIVE	轻快爵士
88	PASODOBLE	平舞土舞
89	TANGO	探戈
90	TANGOARG	阿根廷探戈
WALTZ/MARCH 华尔兹进行曲		
91	GERMWALTZ	德国华尔兹
92	VIENNAWALTZ	维也纳华尔兹
93	MUSETTE	风笛舞
94	SLOWWALTZ	慢速华尔兹
95	MARCH	进行曲
96	MARCH6/8	进行曲6/8
97	POLKA	波尔卡
98	D.POLKA	迪斯科波尔卡
99	SCHLAGER	德国进行曲

DRUM SET TABLE (MIDI CHANNEL 10)

	1 HQ STD SET1	2 CHINESE SET	3 HQ ROOM SET	4 HQ POWER SET	5 HQ ELEC. SET
39 - D#2	High Q				
40 - E2	Slap				
41 - F2	Scratch Push				
42 - F#2	Scratch Pull				
43 - G2	Sticks				
44 - G#2	Square Click				
45 - A2	Metronome Click				
46 - A#2	Metronome Bell				
47 - B2	HQ STD1 Kick2		HQ Room Kick2	HQ Power Kick2	HQ Elec Kick2
48 - C3	HQ STD1 Kick1		HQ Room Kick1	HQ Power Kick1	HQ Elec Kick1
49 - C#3	Side Stick				
50 - D3	HQ STD1 Snare1		HQ Room Snare1	Gated Snare	Elec SD
51 - D#3	Hand Clap				
52 - E3	Snare Drum 2		HQ Room Snare1	HQ Power Snare1	HQ Elec Snare1
53 - F3	HQ Low Floor Tom	大鼓 1	HQ Power Low Tom2	HQ Power Low Tom2	Elec Low Tom2
54 - F#3	Closed Hi Hat [EXC1]				
55 - G3	HQ High Floor Tom	大鼓 2	HQ Power Low Tom1	HQ Power Low Tom1	Elec Low Tom1
56 - G#3	Pedal Hi-Hat [EXC1]				
57 - A3	HQ Low Tom	中鼓 1	HQ Power Mid Tom2	HQ Power Mid Tom2	Elec Mid Tom2
58 - A#3	Open Hi-Hat [EXC1]				
59 - B3	HQ Low-Mid Tom	中鼓 2	HQ Power Mid Tom1	HQ Power Mid Tom1	Elec Mid Tom1
60 - C4	HQ Hi Mid Tom	小鼓 1	HQ Power Hi Tom2	HQ Power Hi Tom2	Elec Hi Tom2
61 - C#4	Crash Cymbal 1				
62 - D4	HQ High Tom	小鼓 2	HQ Power Hi Tom1	HQ Power Hi Tom1	Elec Hi Tom1
63 - D#4	Ride Cymbal 1				
64 - E4	Chinese Cymbal	小堂锣			Reverse Cymbal
65 - F4	Ride Bell	汤锣 1			
66 - F#4	Tambourine	闭小钹			
67 - G4	Splash Cymbal	汤锣 2			
68 - G#4	Cowbell	哑锣			
69 - A4	Crash Cymbal 2	低音堂锣			
70 - A#4	Vibraslap	大堂锣			
71 - B4	Ride Cymbal 2	开小钹			
72 - C5	Hi Bongo				
73 - C#5	Low Bongo				
74 - D5	Mute Hi Conga				
75 - D#5	Open Hi Conga				
76 - E5	Low Conga				
77 - F5	High Timbale	腰鼓 1			
78 - F#5	Low Timbale	腰鼓 2			
79 - G5	High Agogo	木鱼			
80 - G#5	Low Agogo	梆子			
81 - A5	Cabasa				
82 - A#5	Maracas				
83 - B5	Short Whistle[EXC2]				
84 - C6	Long Whistle[EXC2]				
85 - C#6	Short Guiro [EXC3]				
86 - D6	Long Guiro [EXC3]				
87 - D#6	Claves				
88 - E6	Hi Wood Block				
89 - F6	Low Wood Block				
90 - F#6	Mute Cuica [EXC4]				
91 - G6	Open Cuica [EXC4]				
92 - G#6	Mute Triangle [EXC5]				
93 - A6	Open Triangle [EXC5]				
94 - A#6	Shaker				
95 - B6	Jingle Bell				
96 - C7	Belltree				

DRUM SET TABLE (MIDI CHANNEL 10)

	6 HQ TR808 SET	7 HQ DANCE SET	8 BRUSH	9 ORCHESTRA	10 SFX SET
39 - D#2				Closed Hi Hat	*
40 - E2				Pedal Hi-Hat	*
41 - F2				Open Hi Hat	*
42 - F#2				Ride Cymbal	*
43 - G2					*
44 - G#2					*
45 - A2					*
46 - A#2					*
47 - B2	HQ 909 BD	HQ Dance Kick	Jazz BD2	Concert BD 2	*
48 - C3	HQ 808 BD	HQ Elec Kick2	Jazz BD1	Concert BD 1	*
49 - C#3	808 Rim shot				*
50 - D3	808 Snare Drum	HQ Dance snare1	Brush Tap	Concert SD	*
51 - D#3			Brush Slap	Castanets	High Q
52 - E3	HQ 909 Snare	HQ Dance snare2	Brush Swirl	Concert SD	Slap
53 - F3	808 Low Tom2	Elec Low Tom2		Timpani F	Scratch Push
54 - F#3	808 CHH [EXC1]	808 CHH [EXC1]		Timpani F#	Scratch Pull
55 - G3	808 Low Tom2	Elec Low Tom1		Timpani G	Sticks
56 - G#3	808 CHH [EXC1]	808 CHH [EXC1]		Timpani G#	Square Click
57 - A3	808 Mid Tom2	Elec Mid Tom2		Timpani A	Metronome Click
58 - A#3	808 OHH [EXC1]	808 OHH [EXC1]		Timpani A#	Metronome Bell
59 - B3	808 Mid Tom1	Elec Mid Tom1		Timpani B	Guitar Slide
60 - C4	808 Hi Tom2	Elec Hi Tom2		Timpani c	Gt Cut Noise (down)
61 - C#4	808 Cymbal			Timpani c#	Gt Cut Noise (up)
62 - D4	808 HiTom1	Elec Hi Tom1		Timpani d	Double Bass Slap
63 - D#4				Timpani d#	Key Click
64 - E4		Reverse Cymbal		Timpani e	Laughing
65 - F4				Timpani f	Screaming
66 - F#4					Punch
67 - G4					Heart Beat
68 - G#4	808 Cowbell				Footsteps1
69 - A4				Concert Cymbal2	Footsteps2
70 - A#4					Applause
71 - B4				Concert Cymbal1	Door Creaking
72 - C5					Door Closing
73 - C#5					Scratch
74 - D5	808 High Conga				Wind Chime
75 - D#5	808 Mid Conga				Car Engine Start
76 - E5	808 Low Conga				Car Breaking
77 - F5					Car Pass
78 - F#5					Car Crash
79 - G5					Police Siren
80 - G#5					Train
81 - A5					Jet Take-off
82 - A#5	808 Maracas				Helicopter
83 - B5					Starship
84 - C6					Gun Shot
85 - C#6					Machinegun
86 - D6					Lasergun
87 - D#6	808 Claves				Explosion
88 - E6					Dog
89 - F6					Horse Gallop
90 - F#6					Birds
91 - G6					Rain
92 - G#6					Thunder
93 - A6					Wind
94 - A#6					Sea Shore
95 - B6					Stream
96 - C7					Bubble
					*
					*
					*
					*

TECHNICAL SPECIFICATIONS

Keyboard:

- 88-key standard touch response hammer action keyboard

Voice:

- 153 voices
- the maximum coinstantaneous voice: 64
- the keyboard percussive: 1~9 group
- sound effect: 1 group
- volume: 00~127
- octachord: -2~2
- phasic: -7~7
- keyboard split: left hand and right hand voice
- dual voice right hand voice1; right hand vioce2
- harmony and resonance: 10 styles
- DSP reverb styles: 8 styles
- DSP chorus styles: 8 styles
- The DSP reverb and chorus sending level: 00~127
- The DSP reverb and chorus return level: 00~127

Accompaniment:

- 100 styles
- Normal play, keyboard split, single finger chord and fingered chord

Function:

- Demo, Voice, Rhythm, Rhythm volume, Touch, Regist Memory, Bank, Record, Dual, Reverb, Sustain, Touch, Pitch band, X.Pose, Tune, Metronome

Display:

- 122*50mm large LCD screen with multi-function

MIDI function

- receive and sending

Auxiliary port

- direct Input, earphone/auxiliary output, sustain footplate
- MIDI in-out port.

Power output

- 5W*2(used with special DC power supply)
- earphone/auxiliary output: the resistance output: 32 Ω .
- loudspeaker
- 12cm*2+5cm*2 the resistance output 4 Ω

Voltage

- DC 8 ~ 15V

Packing Measurement

- 1465 (L) × 425 (W) × 190 (H)mm

Gross Weight

- 23kg

Net Weight

- 20kg

Gross Weight

- music stand
- owner's manual
- Warranty card
- power supply adaptor

**The Specifications are subject to change without notice.*



WARNING!

INDOOR USE ONLY! PREVENT IT FROM BEING CAUGHT IN RAIN! DO NOT DISSEMBLE IT BY YOURSELF!



WORLD

W3000H OW

HANGZHOU WORLDE DIC