

WELCOME...

To the happy family of WORLDE electronic musical instrument owners! To get the most out of the many features and functions of the keyboard, please be sure to read carefully this manual and keep it at hand for future reference.

MAIN FEATURES

- 88-key standard piano touch response and hammer action keyboard
- Strong multifunctional LCD system with large-screen display, which makes selecting and editing parameters much easier.
- 163 different kinds of well-chosen voices, including 4 voices of Chinese folk instruments(Trichord, Gu-Zheng, Erhu, Suona)
- Almost including 100 popular accompaniment styles in the world. Each rhythm has its own intro and main (A, B), variation and ending.
- 32 types of commonly-used voices and 32 types of commonly-used styles for rapid choice.
- With 9 groups of percussion instrument and a special-effec-voice group, including a group of Chinese traditional percussion instrument.
- Song Recording function can record one accompaniment track and two melody tracks.
- Soft LCD back light makes the piano more luxurious.
- Be able to synthesize certain digital effects like the reverb、 chorus、 and 3 D stereo effect, which could create various sound field effects.
- Minus Channel Mode and Repeated Playback function are excellent for teaching and practising.
- Record function could record one track of accompaniment and two tracks of melody.
- Be able to record user's song.
- Beautiful demo songs, making great contributions to lifting your performance level.
- Memory Bank can reserve at most 8 panel parameter settings and each setting can be recalled whenever you want.
- MIDI function makes his instrument able to connect to any other standard MIDI system.

CONTENT

Safety Precautions P. 2
Control Panel & Terminals	... P. 3
Preparations P. 5
* Setting Up P. 5
* Connections	
Earphone and Audio output P. 6
MIDI input/output P. 6
Listening to the Demo Songs	
... ..	P. 7
Playing the Piano P. 9
* Selecting and Playing a Voice	... P. 9
Percussion P. 11
* Touch Response P. 12
* Dual Voice P. 12
* Harmony/Echo P. 13
* Sustain P. 13
* Sostenuto P. 13
* Soft P. 14
* Transpose P. 14
* Pitch Bend P. 14
Number Effect P. 15
* Using Number Effect P. 15
* Changing the Reverb Effect P. 15
Reverb Style P. 15
* Changing Chorus Effect P. 16
Chorus Style P. 16
* Sustain P. 16
Using Auto Accompaniment	
... ..	P. 17
* Selecting Accompaniment Mode	... P. 17
* Single Finger Mode P. 17
* Fingered Mode P. 18
* Selecting the Style P. 19
* Setting the Tempo P. 19
* Starting the Accompaniment P. 20
* Stopping the Accompaniment P. 22
* Sync Stop P. 22
Registration Memory P. 23
* Register Panel Setting P. 23
* Recalling the Registered Panel Setting P. 24
Song Recording P. 25
* Recording a User Song P. 26
* Accompaniment Track Recording	... P. 27
* Melody & ACMP Tracks Playback	... P. 27
Practice Function P. 28
* Minus Channel Mode P. 28
* Repeated Playback P. 29
Whole Function P. 30
MIDI Functions P. 31
MIDI Interface P. 32
Remote Passage P. 32
Connect to a Personal Computer	... P. 33
Appendix	
* Voice List P. 34
* Style List P. 36
* Drum Set Table P. 37
* Technique Specifications P. 39

SAFETY PRECAUTIONS...

- Locations:
 - Avoid exposure to sunlight.
 - Do not place the item in or near overheated places like car or oven for a long time.
 - Do not place the item in places of moisture, dirty and vibrated.
 - Do not place the item near facilities with strong electromagnetic such as television and radio.

- Avoid strong crash and scratches with hard object.

- Turn off the power supply when not in use. If the item is not in use for a long time, please plug out the power supply cable to avoid any accident.

- Cut the power supply if any of the followings occur:
 - Power supply cable is damaged.
 - Fluid is splashed into/onto the item.
 - Thundering.

- When cutting the power supply, plug out the power socket, rather than pull the cable.

- When connecting to an external power supply, mind the maximum rated power.

- Clean the item with soft and clean cloths. Few amounts of neutral cleanser could be used, but never use solvents which would damage the finishing of the piano, such as alcohol, benzene, paint, or diluent.

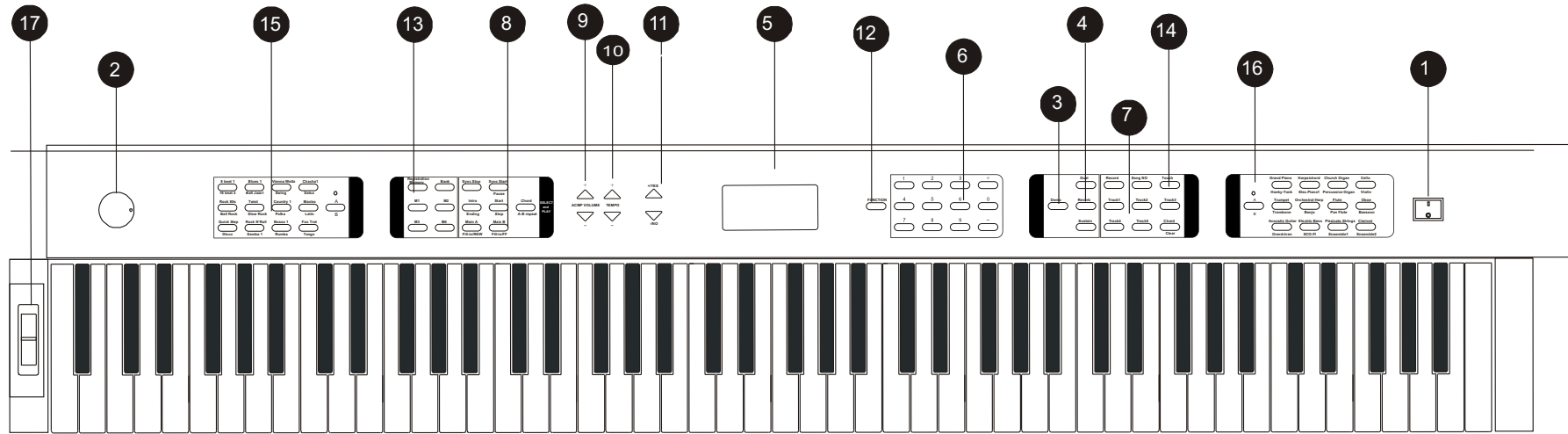

Control Board:

- | | | |
|------------------------------------------------------------------|---------------------------------------|--------------------------------|
| ① POWER Switch P. 7 | RECORDbuttonP.25 | MEMORYbutton P.23 |
| ② MASTER VOLUME dial P. 7 | TracksandClearbuttonsP.25 | M1~M4buttons P.23 |
| ③ DEMO button P. 7 | ⑧ AUTO ACCOMPANIMENT P.17 | ⑭ TOUCHP.12 |
| ④ EFFECT | Sync Start/Stop P.22 | ⑮ STYLE buttonP.19 |
| REVERB button P.15 | Intro/Ending buttonP.22 | ⑯ VOICE button P.9 |
| DUAL buttonP.12 | Main A/BP.22 | ⑰ PITCH BEND roller P.14 |
| SUSTAIN buttonP.13 | SyncStop button.P.22 | |
| | FingeredChordbutton P.22 | |
| | Start/StopbuttonP.22 | |
| ⑤ LCD screen P.11 | ⑨ ACMP Volume buttonP.22 | |
| ⑥ Number buttons[0-9] and [+ /YES],
[- /NO] buttonsP.13 | ⑩ TEMPO buttonP.19 | |
| | ⑪ [+ /YES], [- /NO] buttons..... P.19 | |
| ⑦ SONG MEMORY P.25 | ⑫ FUNCTION buttonP.29 | |
| | ⑬ REGISTRATION MEMORY P.23 | |

External Terminals

REAR PANEL

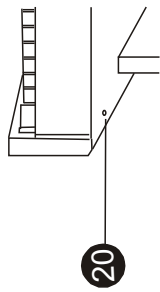
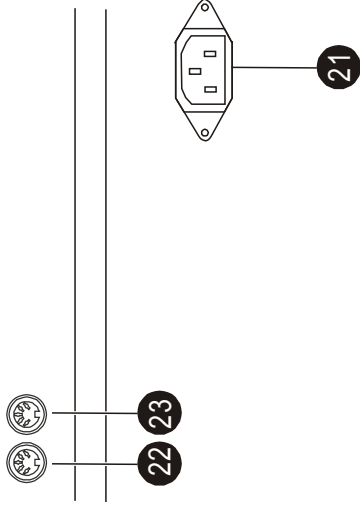

BACK BOARD

FOOT SWITCH

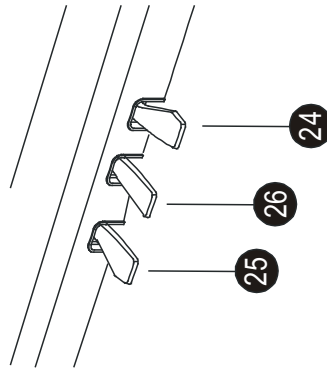

- Front Panel
- 20 Headphone / Auxiliary Output P. 8
- Rear Panel
- 21 AC Adapter Socket P. 7, 9
- 22 MIDI IN P. 8, 51
- 23 MIDI OUT P. 8, 51
- Footswitch
- 24 Sustain Pedal P. 22
- 25 Sostenuto Pedal P. 22
- 26 Soft Pedal P. 22

PREPARATIONS

Setting Up

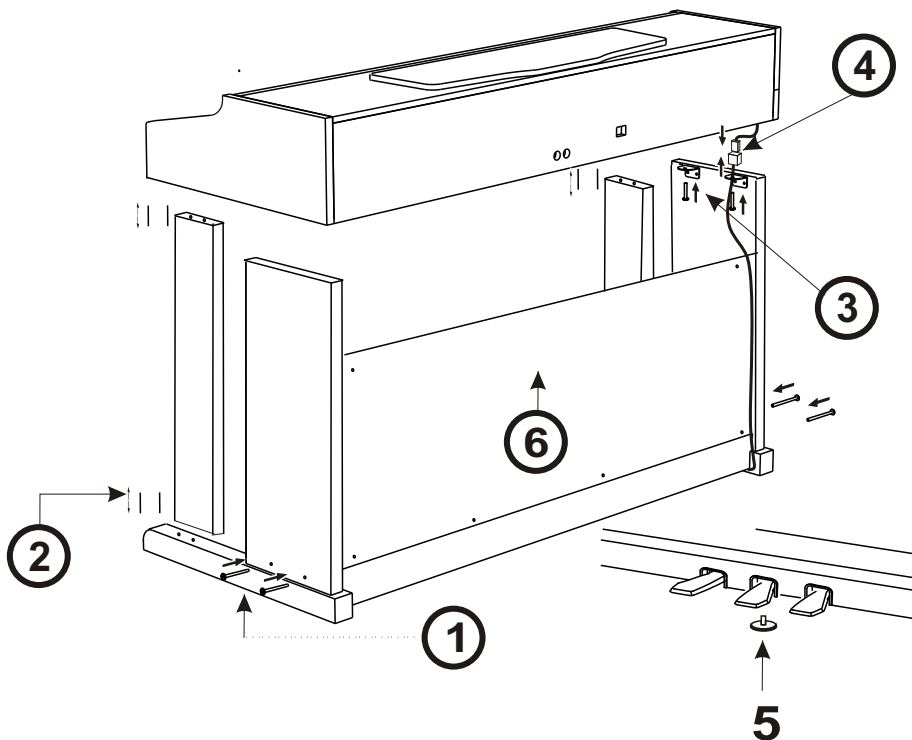

W8822

1. Fix the left and right feet on the ground board with 4 black screws at each side.
2. Put 8 wooden screws into the small holes in the front left and right feet. 4 for each side. Then fix these feet separately on the ground board and ground feet.
3. Place the piano body onto the plank, and fix it with 4 zinc-gilded screws at each side as shows in the illustration.
4. Connect the cable of foot switch with the socket cable (As shown in the illustration).
5. Move the screw between the sustain pedal and soft pedal right onto the ground, in order to pin up the pedal.
6. Use 6 screws to fix the baffle on the angle iron corresponding to the pedal and left & right back feet.

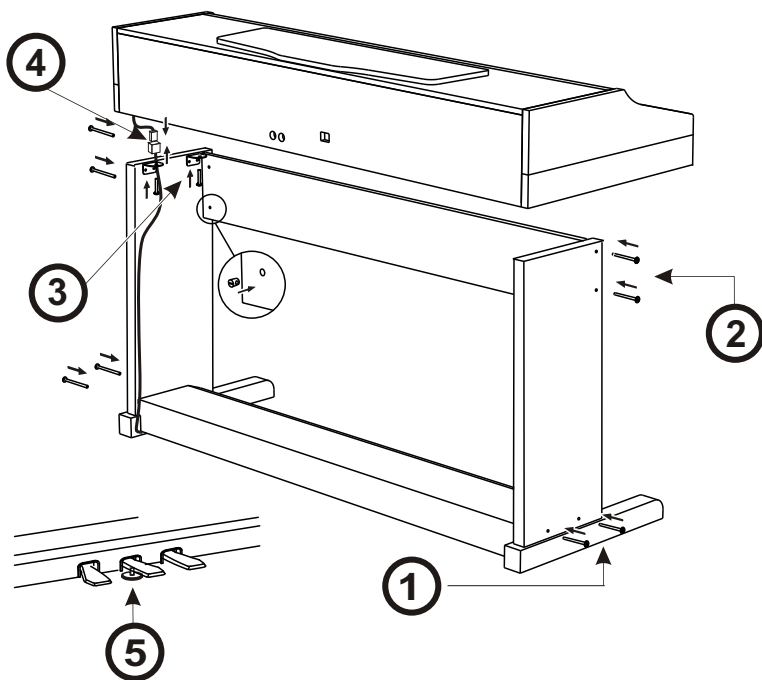

W8821A

1. Fix the left and right feet on the ground board with 4 black screws at each side.
2. Fix the left and right feet on the front panel with 4 black screws at each side.
3. Place the body onto the plank, and fix it with 4 zinc-gilded screws at each side as shows in the illustration.
4. Connect the cable of foot switch with the plug cable (As shown in the illustration).
5. Move the screw between the sustain pedal and damper pedal right onto the ground, in order to pin up the pedal.

■ Basic Operation

- Open the keyboard cover, and set up the music stand.
- Before connecting to the alternating current, be sure to set the [POWER] switch to 0 position. Plug the power supply output into the AC socket, then connect the power supply input to the alternating current. Finally press down the 1, then the screen lights. Adjust the [MASTER VOLUME] dial according to your preference.



POWER

NOTICE

You should wait another 2 or 3 seconds to restart this instrument after you just turn it off, for it needs this time to make the internal circuit discharge completely. Otherwise, some abnormal phenomenon might occur during the performance.

■ Earphone and Audio output

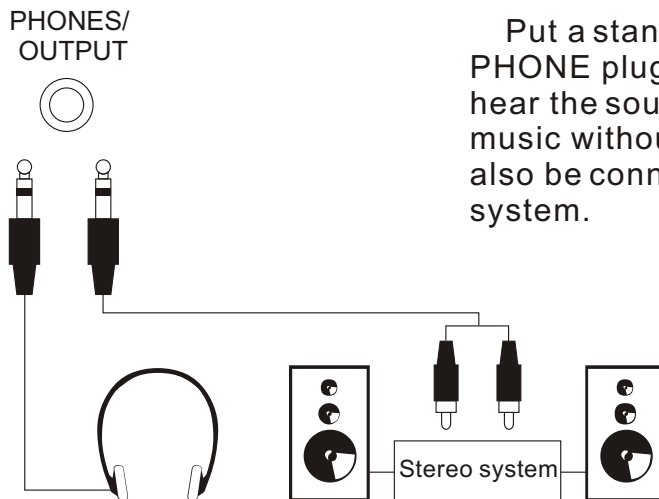

Put a standard earphone to connect the keyboard's PHONE plug. While connection is made, you may only hear the sound inside the earphone and practice the music without disturbing the others. This plug can also be connected to the speaker to have a stereo system.

■ MIDI input/output

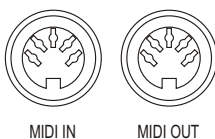

MIDI IN

MIDI OUT

MIDI IN

Receive MIDI Data from the outside devices connected (e.g. Sequencer)

MIDI OUT

Send MIDI Data of this keyboard

LISTENING TO THE DEMO SONGS

■ *. Listen to the Music of the Memory

After installation, you may play this keyboard. Just experience its excellent performance. There are four Demos.

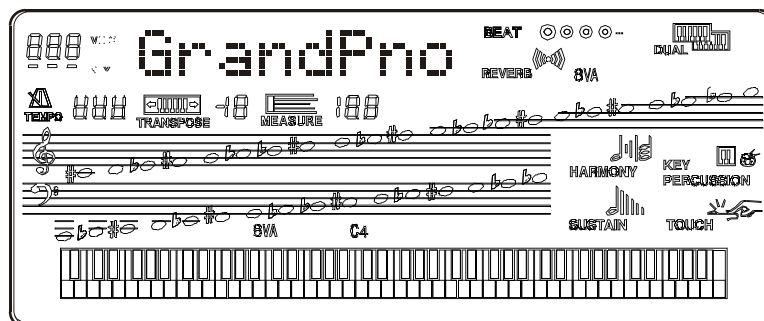

• 1. Tune on the POWER

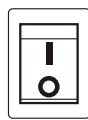

POWER

• 2. Adjust the MASTER VOLUME dial to 1 / 4 circle. You can also adjust it during playback

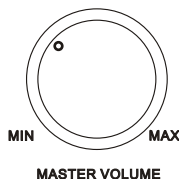

MASTER VOLUME

. It's always a good idea to set the keyboard volume at a relatively low level before playing.

• 3. Press the [DEMO] button

Press the [DEMO] button, this piano will play the music automatically. The name of the first song will appeared on the screen. The songs will be played in order And circularly before being stopped.

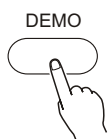

- **4.To Select other demos**

During the demo playback, you can use [+ /YES] and [- /NO] or the number pad to select other demo songs.

Press [PLAY/STOP] button, and this instrument will play from the beginning of the song you have selected.

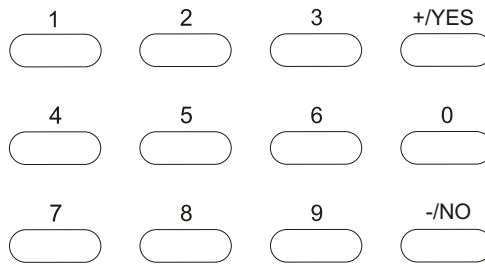
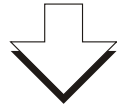

- **5.Quit**

Press [DEMO] or [PLAY/STOP] button to stop the playback, then press [VOICE] button to return to normal performance.

DEMO

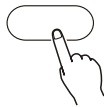

NOTICE:

If you press the [PLAY/STOP] button again after you stopped the playing all the demo songs in order, this instrument only plays the present demo song and stops when the song stops.

PLAYING THE PIANO

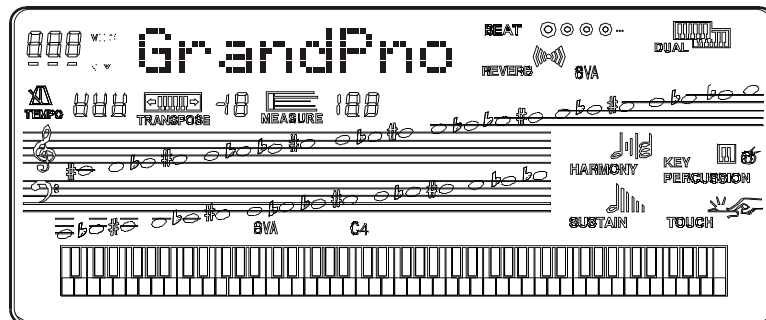

Selecting and Playing a Voice

This instrument comes with 163 built-in voices (01-163) and 10 percussion groups (01-10) for selection.

■ 1. Selecting the normal mode

GrandPno

■ 2. Selecting the Voice Play function

+ / YES



- / NO

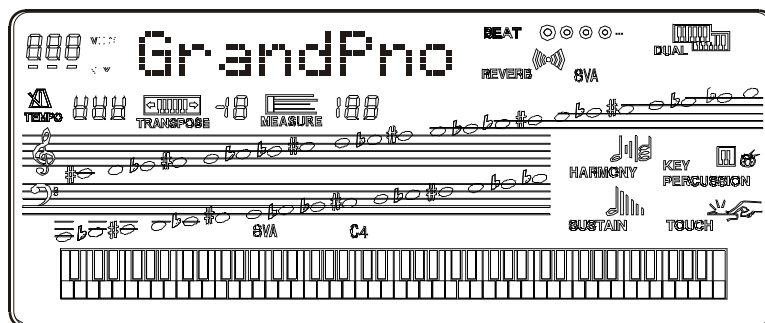

FUNCTION

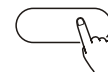

You have to select the Voice Play Function before performance. The easiest way is to press [VOICE] button. Another approach is to keep pressing the [FUNCTION] button until the arrow points to [VOICE], or simply to select the 32 commonly-used voices in the [Voice Selecting] area. When the indicator of [VOICE] A/B is on, it is the voice below the button that is selected, and vice versa.

■ 3. Selecting a Voice

You can use [+ / YES] and [- / NO] buttons or numeric buttons to select any of the 163 voices, which are printed on the panel. And the current voice name and voice number are displayed on the first line of the LCD.

- [+ / YES] and [- / NO] buttons

After entering the Voice Play function, the buttons can change the voice number in order, which could be accelerated by holding the button.

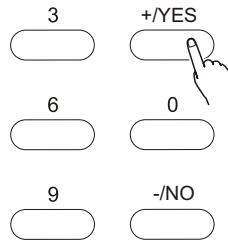

- Numeric buttons

These buttons are used to input the desired voice number. For two-digit numbers (01-99) entries, simply pressing the two numbers in order will be fine. For example, if you want to select voice number 57, you just have to press [5] and [7].

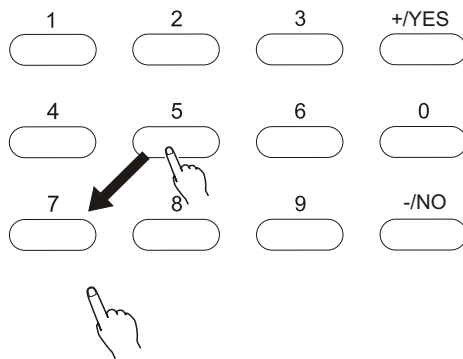

When it comes to three-digit number entry, hold [1] until it appears at hundred's place, then input the next two numbers following the same procedure as above.

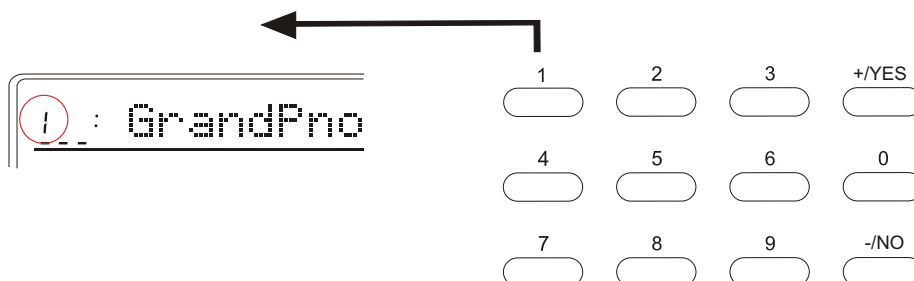

■ 4.Adjusting the Volume

First try the keyboard and then adjust the volume to a suitable place.

NOTICE

In the Whole Function team, the keyboard volume and the accompaniment volume can be separately adjusted. Holding down the [VOICE] button can quickly select the keyboard volume function. More information please refer to P. 46.

PERCUSSION

■ 1. Selecting the PERCUSSION FUNCTION

Keep pressing [Function] button until the arrow points to VOICE and then select one of the 10 groups of percussion with the [+ /YES] and [- /NO] buttons, the relative name of the percussion will be displayed on the LCD.



■ 2. Selecting the PERCUSSION TEAM

01	STANDARD DRUMS	02	CHINESE PERCUSSION GROUPS
03	ROOM DRUMS	04	ROCK DRUMS
05	ELECTRIC DRUMS	06	T808 DRUMS
07	JAZZ DRUMS (same as 01)	08	BRUSH KIT
09	CLASSIC DRUMS	10	SFX KIT

Notice:

**.while selecting the Percussion, you may not use the DUAL and the HARMONY function At the same time. These functions will automatically close.*

TOUCH RESPONSE

*. Press the [TOUCH] button may open/close the keyboard touch function. While this function is on, the relative icon appears on the screen display, and the touch sensitivity (TouchSns) can be adjusted in whole function group. While the function is closed, the keyboard will produce the same volume to simulate instruments without such touch response, such as the ORGAN & CLASSIC PIANO.



*. This function automatically open when the power switch turns on.
 Press the [TOUCH] button to quickly select the parameter of the touch sensitivity.
 More information please refer to P 48.

DUAL VOICE

*This function make available the keyboard play two combined voices at the same time.
 One voice is selected by the normal function, and another voice by this function.

Press this button to turn on/off the second voice. While the function is selected, the relative icon appears on the screen display.



————— Selecting the relative parameters of DUAL —————

■ Selecting the DUAL MODE

Press the FUNCTION buttons till the “arrow” points to the DUAL Mode position.

Use [+ / YES] and [- / NO] buttons or numeric buttons to select parameter settings, the current setting is displayed on the first line of LC.

Notice:

*. Press [FUNCTION] button to edit the settings of the second voice.

*. Percussion can not be applied to Dual.

*. Press [+ / YES] and [- / NO] buttons at the same to return to the initial setting of the second voice: 70.

■ Quit

Press the [VOICE] button or select the other function to quit from this mode.





HARMONY/ECHO

■ Selecting Harmony/Echo function

Press [FUNCTION] button until the arrow points to Harmony/Echo.

■ Selecting the type of Harmony/Echo

10 kinds of harmony/echo can be selected with [+ /YES], [- /NO] buttons or numeric buttons.

TYPE	EXPLANATION	
01:Duet	Double-voice Harmony, 2nd voice lower than the melody	
02:Octave	Add a bass octave to the melody	
03:Tremolo 1/4	Produce the tremolo 1 / 4	
04:Tremolo 1/6	Produce the tremolo 1 / 6	
05:Tremolo 1/8	Produce the tremolo 1 / 8	
06:Tremolo 1/12	Produce the tremolo 1 / 12	
07:Echo 1/4	Produce the Echo 1 / 4	
08:Echo 1/6	Produce the Echo 1 / 6	
09:Echo 1/8	Produce the Echo 1 / 8	
10:Echo 1/12	Produce the Echo 1 / 12	

■Quit

Press [- /NO] and [+ /YES] buttons to close harmony or to select another Function to quit from harmony/echo..

SUSTAIN PEDAL

* Sustain Pedal (23): Using this pedal can bring sustain effect to the melody.

SOSTENUTO PEDAL

* Sostenuto Pedal (24): Using this pedal can sustain one note or one chord and meanwhile having no effect on other notes.

SOFT PEDAL

* Soft Pedal (25): Using this pedal can diminish the sound of the melody.

TRANPOSE

*.This function can transpose the note up/down one octave by every half note

■ Select the parameters of transpose



Use the CURSOR buttons to select the number at right side of the “TRANPOSE” in the screen display, which makes the number flash.

■ Set the parameter you need

Use the [+ / YES], [- / NO] buttons to select the parameter number (-12 to +12). 0 stands for the standard pitch.

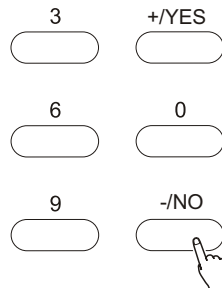

NOTICE:

*.Hold [-/NO] button and press numeric buttons to input

PITCH BEND

The roller on the left side of the keyboard could change the volume of the keyboard. Up to rise and down to reduce.

The extension could be set by the “PBRange” parameter by the Whole Function.

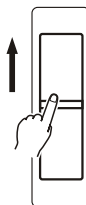

NUMBER EFFECT

USING NUMBER EFFECT

This instrument provides many Number Effects: 8 Reverbs; 8 Chorus; sustain effect to make your performance more perfect.

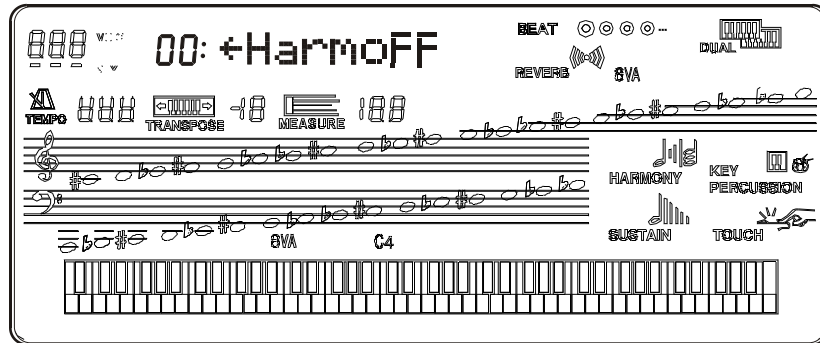

Reverb

CHANGING THE REVERB EFFECT

Selecting the Reverb Style

- **Selecting the Reverb function**

Hold the [REVERB] button for 3 seconds till the reverb function styles appear on the LCD, then select one of the 8 reverb styles with [+ / YES], [- / NO] buttons, the name of the current reverb style displayed on the first of the LCD.

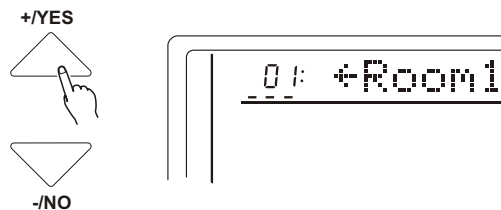

Notice:

Press [+ / YES] and [- / NO] buttons at the same time to return to the initial setting..

Reverb Styles

01:ROOM1	02:ROOM2
03:ROOM3	04:HALL1
05:HALL2	06:PLATE
07:DELAY	08:PANNINGDELAY

CHANGING THE CHORUS

Selecting the Chorus Style

■ Selecting the Chorus Function

Press the FUNCTION button till the chorus styles appear on the LCD. Then select one of the 8 chorus styles with [+ / YES], [- / NO] buttons. The name of the current chorus is displayed on the first line of LCD.

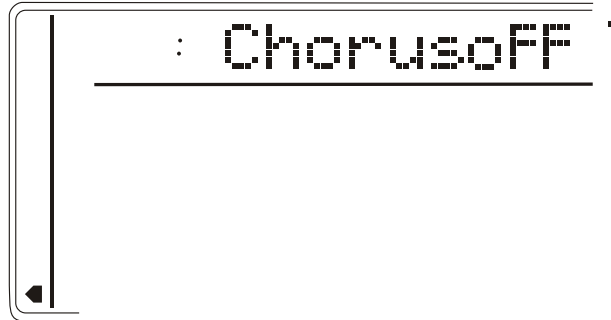

■ Quit

Press [+ / YES] and [- / NO] buttons or select other functions to quit from chorus mode.

CHORUS STYLE

01: CHORUS1	02: CHORUS2
03: CHORUS3	04: CHORUS4
05: FEEDBACK CHORUS	06: FLANGER
07: SHORT DELAY	08: SHORT DELAY WITH FEED-BACK

Notice:

The settings of chorus have effect on every voice.

The chorus return level of each voice (including dual) can be set separately.

SUSTAIN

Press [SUSTAIN] button on the panel to turn on this function, press again to turn off.

USING AUTO ACCOMPANIMENT

This instrument comes with 100 built-in styles, providing a complete band or style accompaniment. The auto-played bass and chord could match your performance and personal style perfectly. (When using auto accompaniment, the maximum number of notes played at the same time will be reduced accordingly.)

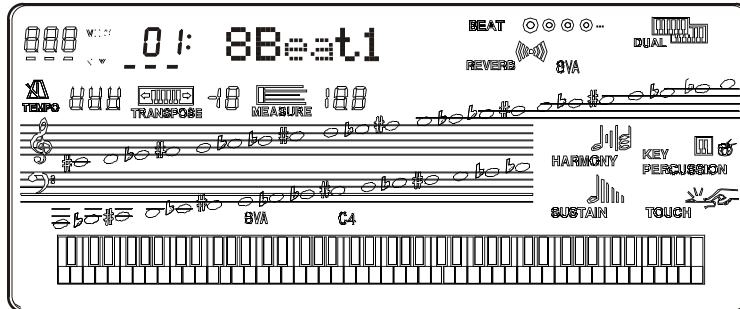

■ Selecting Chord Accompaniment Mode

Keep pressing the [CHORD] button till SINGLE FINGER OR FINGERED appears on the LCD.

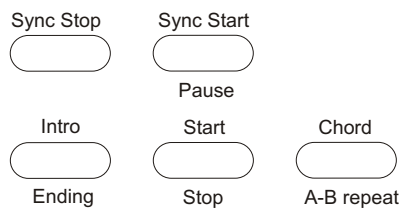

■ *.SINGER FINGER MODE

Under this mode, the chord accompaniment lets you play four types of chords with one or two fingers..

Example

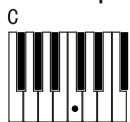

Major

Chord Types

Major chord---Press the root note of the chord.



Minor

Minor chord----Press the root note together with the nearest black key to the left of it.

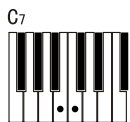

Seventh

Seventh chord----Press the root note together with the nearest white key to the left of it.



minor seventh

Minor seventh chord----Press the root note together with the nearest white and black keys to the left of it (three keys altogether).

■ *. FINGERED MODE

Under this mode, the left keyboard (In Style mode, the split point always lays at key no. 54) plays the accompaniment chord. The following chords listed are recognizable. (Take C chords for example, notes in parentheses can be omitted.)

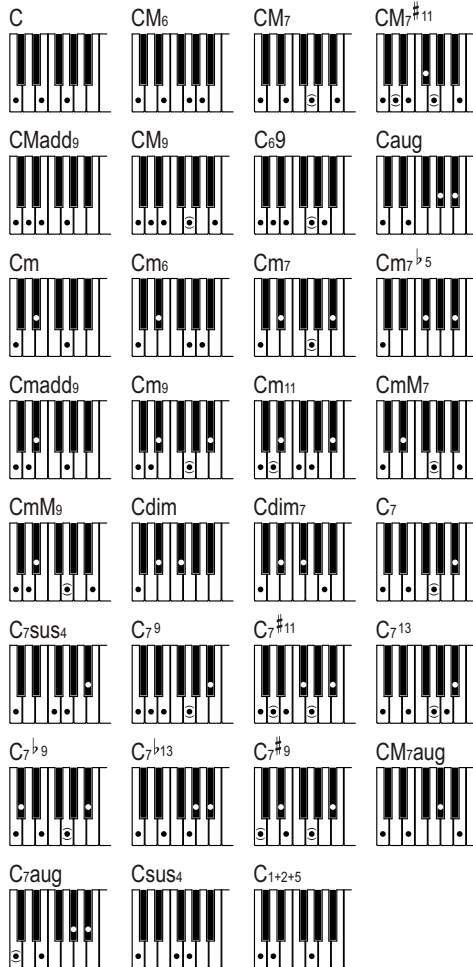

CHORD NAME	ABBREVIATION	
MAJOR	M	1-3-5
MAJOR SIXTH	M6	1-3-5-6
MAJOR SEVENTH	M7	1-3-(5)-7
MAJOR SEVENTH SHARP ELEVENTH	M7#11	1-(2)3#4-(5)-7
MAJOR ADD NINTH	Madd9	1-2-3-5
MAJOR NINTH	M9	1-2-3-(5)-7
MAJOR SIXTH ADD NINTH	69	1-2-3-(5)-6
AUGMENTED	aug	1-3-#5
MINOR	m	1b3-5
MINOR SIXTH	m6	1b3-5-6
MINOR SEVENTH	m7	1-b3-(5)-7
MINOR SEVENTH FLATTED FIFTH	m7b5	1-3-5-7
MINOR ADD NINTH	madd9	1-2-3-5
MINOR ADD NINTH	m9	1-2-3-5
MINOR MAJOR ELEVENTH	m11	1-3-(5)-7
MINOR MAJOR NINTH	mM9	1-2-3-(5)-7
DIMINISHED	dim	1-3-5
DIMINISHED SEVENTH	dim7	1-3-5-6
SEVENTH	7	1-3(5)-7
SEVENTH SUSPEND FOURTH	7sus4	1-4-5-7
SEVENTH NINTH	79	1-2-3-(5)-7
SEVENTH SHARP ELEVENTH	7#11	1-(2)3-#4-(5)-b7
SEVENTH THIRTEENTH	713	1-3-(5)-7 2-3-5-6-7
SEVENTH FLATTED NINTH	7b9	1-2-3-(5)-7
SEVENTH FLATTED THIRTEENTH	7b13	1-3-5-6-7
SEVENTH SHARP NINTH	7#9	(1)-#2-3-(5)-7
MAJOR SEVENTH AUGMENTED	M7aug	1-3#-5-7
SEVENTH AUGMENTED	7aug	(1)-3-#5-7
SUSPEND FOURTH	sus4	1-4-5
ONE PLUS TWO PLUS FIVE	1+2+5	1-2-5

NOTE:

- Notes in parentheses can be omitted.
- Playing two same root keys in the adjacent octaves produces accompaniment based only on the root.
- A perfect fifth (1+5) produces accompaniment based only on the root and fifth which can be used with both major and minor chords.
- The chord fingerings listed are all in “root” position, but other inversions can be used with the following exceptions: m7, m7 b 5, 6, m6, sus4, aug, dim7, 7 b 5, 6(9), 1+2+5.
- Inversion of the 7sus4 and m7(11) chords are not recognized if the notes shown in parentheses are omitted.
- The auto accompaniment will sometimes not change when related chords are played in sequence (e.g. some minor chords followed by the minor seventh).
- Two-note fingerings will produce a chord based on the previously played chord.

■ Selecting the STYLE Function

Press the [8 Beat 1 button to select this function. This function can also be selected by pressing [FUNCTION] button until the arrow points to STYLE.

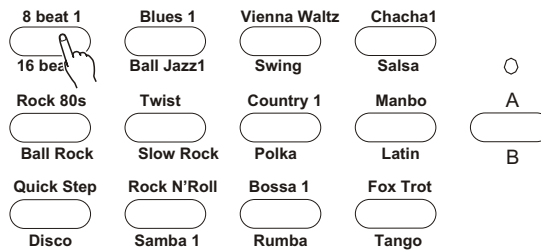

■ Selecting one STYLE

Select one of the 100 styles with [+ / YES], [- / NO] buttons or numeric buttons, with the current style and number displayed on the first line of the screen. Or select directly from the 32 commonly-used styles on the STYLE CHOICE area.

■ Setting the TEMPO

Every Style type has its own Tempo. It displays on the right side of the TEMPO mark. While the Accompaniment is started, this Tempo will not be changed even if you select any other Style at the same time.

To select the Tempo of 40-240/tempi by the TEMPO ▲▼ buttons. Every press to increase one tempi. Keep pressing to quicken the procedure. Press the TEMP ▲▼ at the same time to return to the original tempo.



■ Start the Accompaniment

*.Direct start:

Press the [START/STOP] button, rhythm will start playing the current choice A or B without Bass or chord.

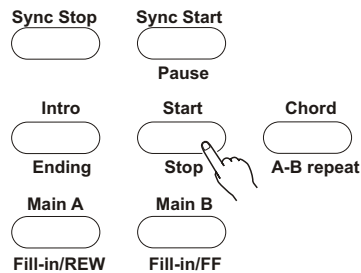

*.Started from Intro, and then play the Main [A]

Press the [INTRO] button, and then press the [A] to make the light on. (If the light is already on, then you do not have to press this button.)

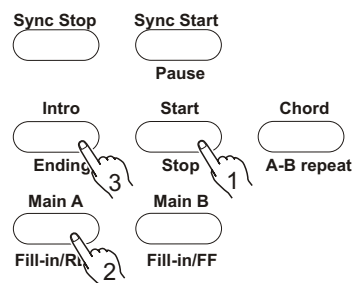

*.Started from Intro, and then play the Main [B]

Press the [INTRO] button, and then press the [B] to make the light on. (If the light is already on, then you do not have to press this button.)

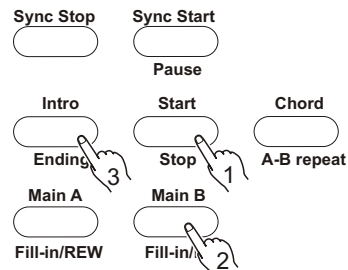

*. SYNC Start

Press the [SYNC/STOP] button to enable you to play any style of the accompaniment while you first press the Split Point in the left keyboard. 54(F#3).

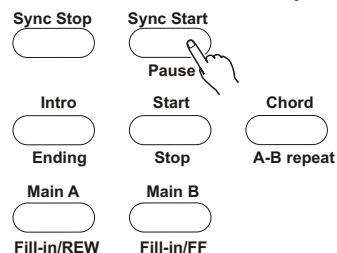

Pressing the [SYNC/STOP] button only makes the accompaniment play after you first press a key on the left hand of the keyboard. Pressing the [SYNC/STOP] button first and then press the [INTRO]& [MAIN] buttons enables you to have the Sync with intro. While selecting the Sync style, tempi light flashes and shows the current tempo. Pressing the [SYNC/STOP] button again before playing will cancel this function.

Notice:

*. While playing, you may also select the [INTRO] button to play Intro.

*. Press the [SYNC/STOP] button to stop the accompaniment and enter into the Synchro.

*. The Split Point setting could be changed by the Whole Function.

■ **Using Auto Accompaniment**

This instrument will automatically recognize the chord while you are playing the left part, and it can play the proper bass chord for the current style. Even if your left hand has released the keys, it will still automatically continue playing. The name of the chord displays in the screen.

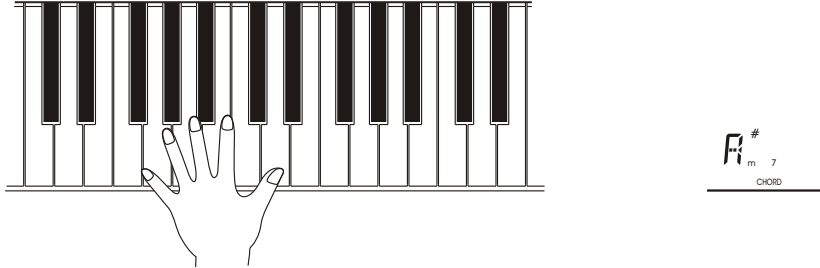

*. **BEAT display**

In the BEAT part shows current Beat.

	4/4 time	3/4 time
1st beat	● ● ● ●	● ● ● ●
2nd beat	● ● ● ●	● ● ● ●
3rd beat	● ● ● ●	● ● ● ●
4th beat	● ● ● ●	BEAT
	BEAT	

■ **To select Main (A) or (B)**

While playing, you can freely choose Main [A] or [B]. After you press [A] or [B], this keyboard will automatically add in a kind of fill-in(altogether 2 kinds), in order to make the change smoothly. This is also available for the same part. For example: While you are playing Main [A] and press the Main [A] at the same time, this keyboard will quickly fill in, and then continuously play the Main [A]. The same for different Main.

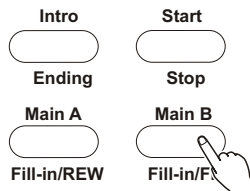

■ Stopping the Auto Accompaniment

Press [START/STOP] button to stop accompaniment. Or press [ENDING] button to stop it after the ending. The Ending will start from the beginning of next measure.

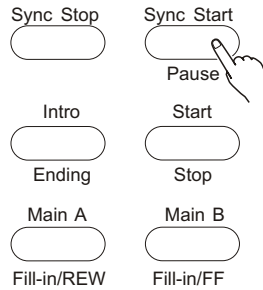

● Quiescence Accompaniment Function

Under the function of Single Finger & Fingered, after you stop the accompaniment, if you play on the left part of the keyboard, it will continue playing proper bass chord that's suitable for your performance.

■ Press [Sync Stop] button

This function makes it possible that the auto-accompaniment stops/pauses as soon as your fingers leave the auto accompaniment area on the keyboard. Replay the chord to restart auto accompaniment. This function very useful when you want to add dynamic interlude in your performance, for instance, you can stop the style and melody when you play an interlude or solo with your right finger.

● Press [Sync Start] to enter into auto accompaniment, then press [Sync Stop]

Turn on Accompaniment function, press [Chord] button enter into singer finger or fingered mode, play a chord on the keyboard (in the auto accompaniment area). The style and chord are automatically on when playing. Press [Sync Stop] again to turn it off.

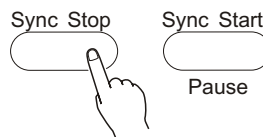

- Release the chord to stop auto accompaniment. Playing the chord again to restart auto accompaniment,
- If you want to close Sync Stop function, just press [Sync Stop] button will do. Press [Start/Stop] button to close the styles completely.

REGISTRATION MEMORY

REGISTER PANEL SETTING

The memory of this instrument can record 8 parameters of panel setting. It could be recalled at your service.

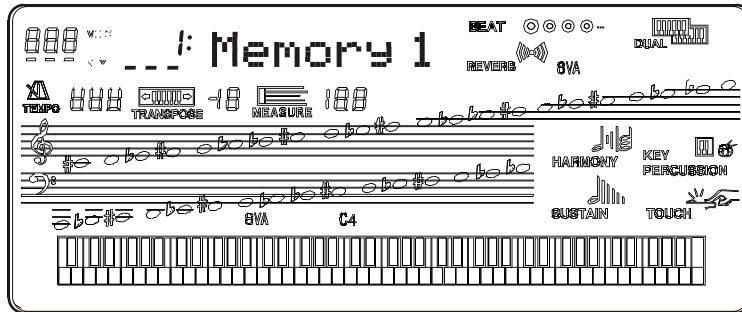

■ Setting the control buttons

The following setting could be saved.

- *. Voice number
- *. Accompaniment Volume
- *. Chorus Level
- *. Tempo, Transpose
- *. Mode (Normal; Duel; Fingered; 8 Finger)
- *. Style number
- *. Percussion group
- *. Keyboard volume
- *. Reverb level
- *. Touch sensitivity
- *. Dual parameters
- *. Chorus(style, return level)
- *. Acmp track data(on/off, Vol,Tone)

■ 2.Registering the setting

while holding down the Memory button, press a memory number button (M1-M4) to make this keyboard memory a new setting. The former data will be erased.

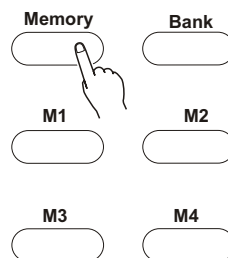

RECALLING THE REGISTERED SETTING

*After select a Memory Bank, press the registration memory number button may recall the corresponding parameter setting. The register number will appear in the screen at the REGIST position. And the parameters will appear in the screen.

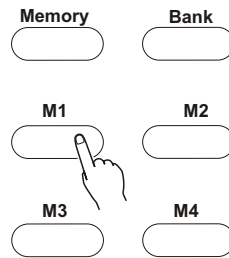

SONG RECORDING

*. Song recording is to record your performance (5 melody parts) and accompaniment(chord part), and save as a song, and replay the song whenever you want. This item can save up to 5 songs. The song recording function has 8 control buttons: [Song Number] for song selection, [Record] for record preparation, [Track1-5] for melody track selection, and [Chord/Clear] for chord track recording selection and or chord track clearance.

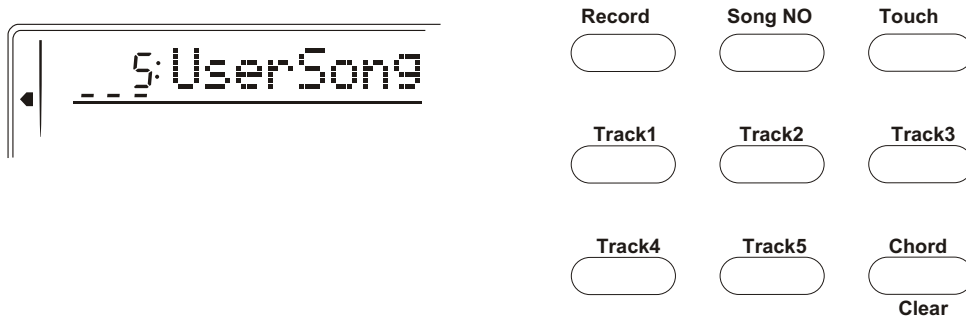

As a matter of fact, this function provides with 5 musical tracks available for saving the melody (Melodies in each track can choose different kinds of voices and percussions) and one special track to save the accompaniment (using Style mode or auto bass chord function). Please save the songs with the methods below:

- Save any melody track or chord track. (Single track record)
- When the auto bass chord function is on, save the melody track and chord track together.(Double tracks record)

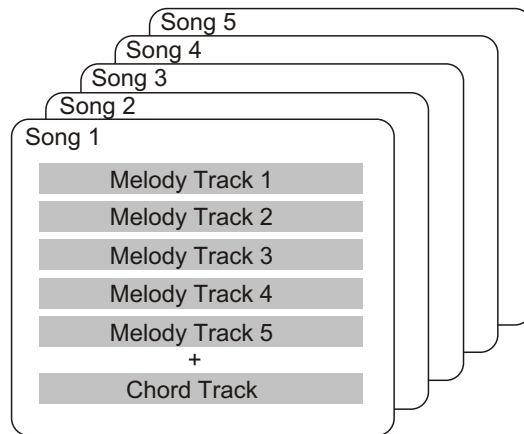

NOTE:

There's no special difference between single-track recording and double-track recording. Even when you record the melody and chord performance by double-track recording, this instrument can automatically separate it into melody track and chord track according to your performance. Thus, you can re-record a certain track (or correct an error) after double-track recording.

In addition, each track can save what stated below

- Melody1-5: the melody played on the keyboard, voice, dual on/off(and the choice of the second voice), dual balance, reverb on/off, sustain on/off, pitch bend roller, touch response on/off, percussion, chord on/off(with the parameters you've set), transpose on/off(with the parameters you've set).

NOTE:

Both the beginning tempo and the tempo change in the recording will be recorded as parts of the song.

- Chord: the chord played on the keyboard (regardless of auto bass chord mode), Style choice, accompaniment proceeding (intro, fill-in, ending, A/B

RECORDING A USER SONG

■ The data that can be recorded to normal(melody) tracks

- *. Note ON/OFF
- *. Touch ON/OFF and scope
- *. Voice number
- *. Reverb ON/OFF and scope
- *. Chorus style ON/OFF
- *. Glide
- *. Sustain ON/OFF
- *. Tempo, time signature
(if it is not in the chord track)

The data that can be recorded into Chord track

- *. Style Number
- *. Chord changes and timing
- *. Section changes(Intro, Main A/B, Fill-in, Ending, etc.)
- *. Accompaniment Vol
- *. Tempo, time signature
- *. Reverb scope

*. Those settings can only be recorded only once when the music begins, while others can be changed during playing.

■ Selecting a Song Number

Press [Song Number] button, and then press [+ / YES], [- / NO] button to select the desired song number.

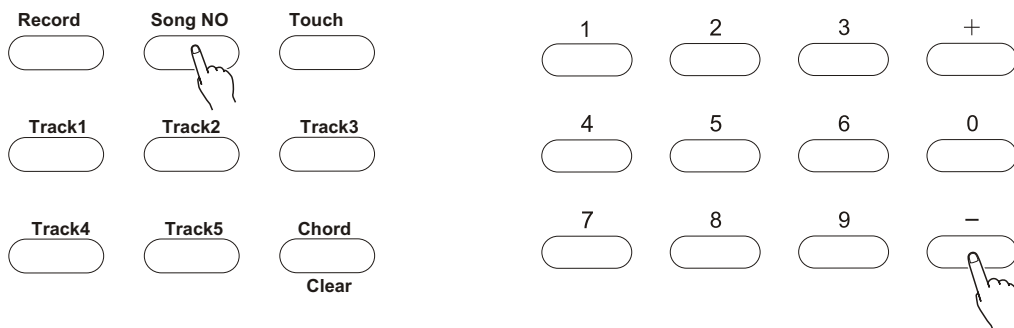

■ Selecting a track number

While holding down the [RECORD] button, press the appropriate Song Memory button. Melody track 1 to 5 can only be chosen once at a time and the display light of time signature flicks. The track number temporarily appears in the LCD before it recovers to its the previous display.

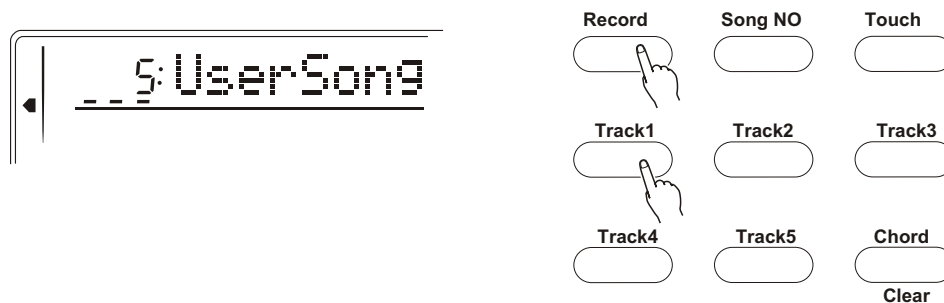

Notice:

Keep in mind that all recording operations replace all the information recorded before. In other words, if you record to a track that already has recorded data, all previous data in the track will be erased and replaced by the newly recorded data.

■ Recording to the Chord Track

A special chord track is prepared for recording accompaniment data. This is automatically recorded to the Chord track(track A). Selecting the chord track will also automatically turns on the accompaniment.

- Press [Record] and [Chord] button at the same time, then play a chord in auto accompaniment area, the accompaniment will be on and you can play the song and the chord along with the style and go on with recording.

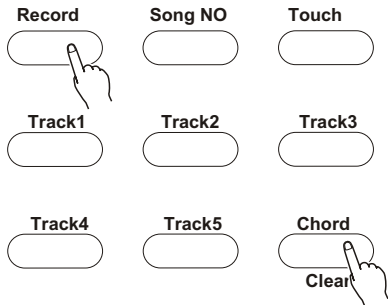

Notice:

User's song No. 1-5 can record up to 5 different accompaniment track (accompaniment chord). And the 5 tracks(1-5) of one user song can only use one accompaniment track. If you record on the user song that is already recorded with accompaniment tracks, the new recorded accompaniment will erase and replace the original accompaniment chord.

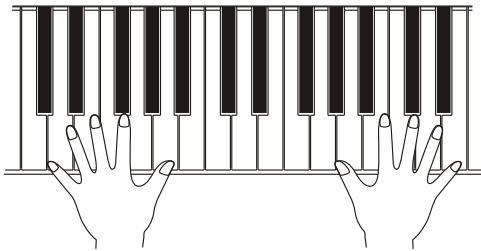

- **Stop recording**
Press the [Start/Stop] button, or [Record] button to stop recording.
- **Playing the recorded song**
You just need to press [Start/Stop] again to play the recorded song from the beginning, and press once again to stop playing.

Notice:

*.If the previous accompaniment track or melody track is on, it can be monitored during the recording. If that track is not needed, you can press its button again to close it.

*.If only one single track is to be played, press other tracks (accompaniment track, 1-5tracks) for 2 seconds, the closed track will not make sound.

*.If no power is provided, the recorded data can only be reserved for one week or more. Important data should be stored in other equipment through the function of batch output.

PRACTICE FUNCTION

*. This instrument provides two functions to help you practice.

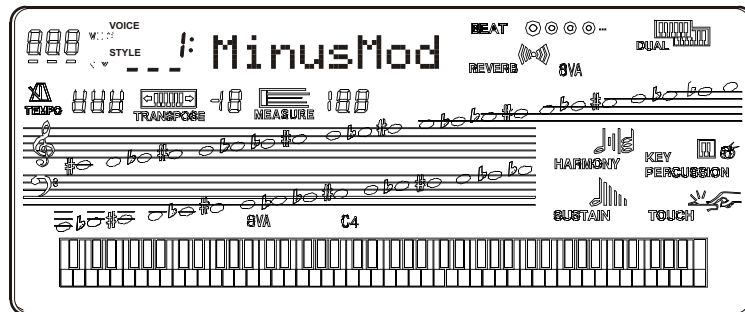

MINUS CHANNEL MODE

- Under this mode, the left/right part of the keyboard of the demo could be closed. TO make you more convenient to follow the playing. “MinusMod” of the Whole Function has a parameter to control the Channel.

Press the [Function] button to open this function. Press [+ / YES] and [- / NO] buttons to close the appointed part.

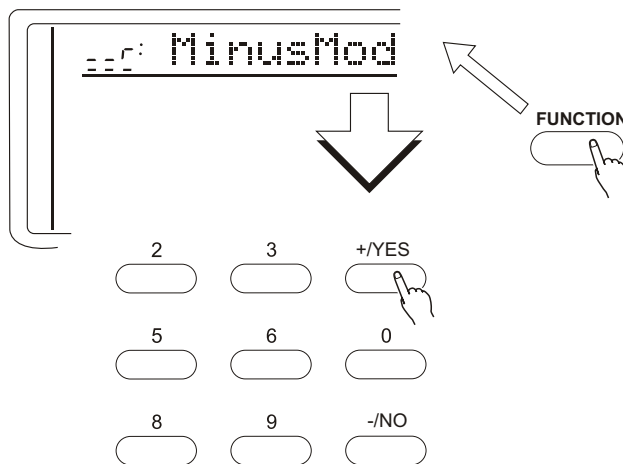

Mode	Part Turned Off
--r	Left hand MinusMod
L--	Right hand MinusMod
L_r	Both hand MinusMod

Notice:

*. Minus Channel Mode has no effect on the song you record by yourself.

*. When the power switch turns to ON, this keyboard will automatically select r (right hand MinusMod)

REPEATED PLAYBACK

- This function lets you repeat a certain part of the song. During playback, press the [REPEAT] button at the beginning of your desired part(A shows in the screen) and press it again at its end(B shows in the screen). Then it can repeatedly play the part you desired until you press the [REPEAT] button again.

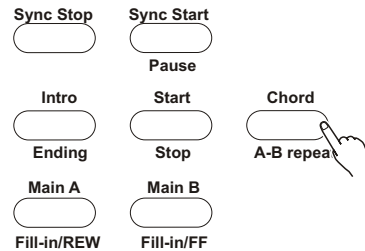

Also you can set the part you want to repeat even if the playback is off. Use measure parameter to set point A and then press the [A-B repeat] button. Then set point B, and press [A-B repeat] button again. Press the [Start/stop] button to start the playback of the part you desired.

Press [A-B repeat] button to close this function.

Notice:

If you set the point A only, the repetition will start from A to the end.

For example, you set the point A at measure 2 and point B at measure 8, the repetition will play from measure 2 to 8.

FAST FORWARD/REWIND

- While playing the demo songs, fast forward and rewind functions can be set according to your needs.

Press [Main A/ Fill in/RW] button to return to the beginning of the demo song

Press [Main B/ Fill in/FF] button to speed up the song playing.

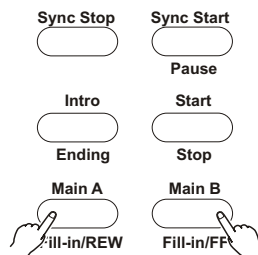

WHOLE FUNCTION

Some of the operations in the WHOLE FUNCTION have been introduced before. But some have not. And we are going to introduce the new ones.

What displays in the screen are the abbreviations of the Functions. The following list their full names and their parameter extensions.

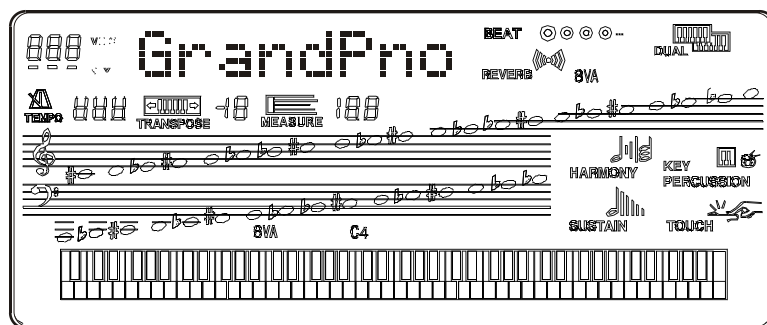

FUNCTION

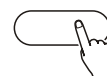

Function	Display	extension
Minus Off	Minusoff	--R, L--, L-r
Harmony	Harmoff	OFF, 1~8
Chorus	Chorsoff	OFF, 1~8
Transpose	Transp	-12~0~12
Tuning	Tuning	-100~100
Dual Volume	D_Volume	00-27
Metronome	Metroff	On-Off

Notice:

All the above functions can use [+ / YES] and [- / NO] button to choose function type.

MIDI FUNCTIONS

W8822 and W8821A are MIDI-compatible, featuring MIDI IN and MIDI OUT terminals and providing a variety of MIDI-related controls. By using MIDI functions, you can expand your musical possibilities. In this chapter, it mainly talks about what MIDI is, what it can do, and as well as how you apply MIDI to W8822 and W8821A.

WHAT IS MIDI?

No doubt you have heard the terms----acoustic instruments and digital instruments. In the world today, these are the two main categories of musical instruments. Let's consider an acoustic piano and a classical guitar as representative acoustic instruments. They are easy to understand. With the piano, you strike a key, and a hammer inside hits some strings and plays a note. With guitars, you directly pluck a string and the note sounds. But how do digital instruments go about playing a note?

Acoustic guitar note production

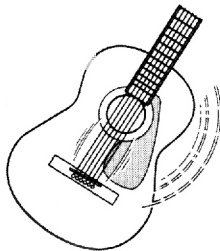

Pluck a string and the body resonates the sound.

Digital instrument note production

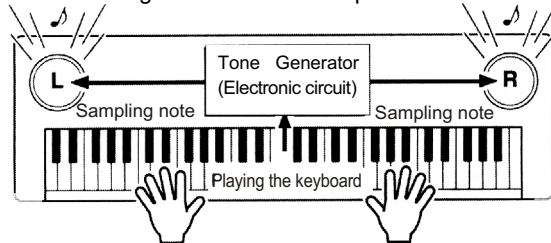

Based on playing information from the keyboard, a sampling note stored in the tone generator is played through the speakers.

As shown in the pictures above, in digital instruments, the sample notes (reserved notes) stored in the tone generator section (electronic circuit) can be played when the information on the keyboard is collected. Then what is the information on the keyboard? For instance, if you use this instrument to play a C quarter note, unlike an acoustic instrument that puts out a resonated note, it puts out information from the keyboard such as “with what voice” , “with which key” , “about how strong” , and “when was it pressed” and “when was it released” . All the information will be converted to a number value and sent to the tone generator. Based on these data, the music source will adopt stored sample note and play it.

MIDI FUNCTION

MIDI is the abbreviation of musical instruments digital interface. It allows the digital instruments to communicate with each other, by sending and receiving compatible notes, control change and program change, and as well as other types of MIDI data and information.

MIDI is an international standard. It enables all the instruments to connect together, and allows them to control each other and exchange data. That is, it makes all the instruments a system, and greatly enlarges its function.

W8822 and W8821A can control MIDI device by transmitting note-related data and various types of controller data, and also can be controlled by outside MIDI information, which can automatically decide the music source mode, and choose MIDI track, voice and effect, and change the parameter and as well as perform the appointed voice.

■MIDI Interface

MIDI IN is to receive outside data from other MIDI devices like sequencer in order to control this instrument; MIDI OUT is to send MIDI data (like the note and touch data) from this instrument.

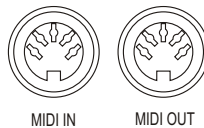

■REMOTE PASSAGE

To set the MIDI passage to receive outside keyboard data, please select 01-16. The outside keyboard must set the source passage from which the data is sent and its MIDI OUT connects this keyboard's MIDI IN by the MIDI cable. When set is OFF, this keyboard will receive from all the 16 tracks. Pressing [-/NO] and [+ /YES] buttons at the same time can retune to the original setting (OFF).

■KEYBOARD OUTPUT

To determine whether the data output from the MIDI OUT.



Never use MIDI cables longer than about 15m. Cables longer than this can pick up noise which can cause data errors.

CONNECT TO A PERSONAL COMPUTER

By connecting your W88222/W8821A MIDI terminals to a personal computer, you can have access to a wide variety of music software.

- When using a MIDI interface device installed in the personal computer, connect the MIDI terminals of the personal computer and the instrument.

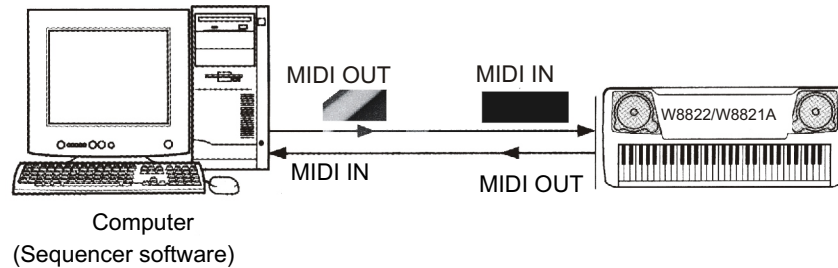

- When using a MIDI interface with a Macintosh series computer, please connect the RS-422 terminal of the computer (Modem port or printer terminal) to the MIDI interface, as shown in the diagram below.

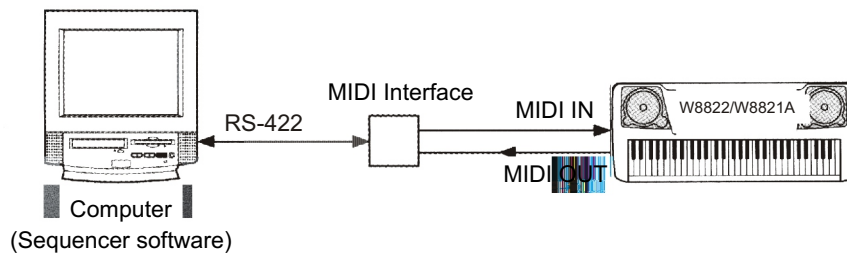

- When connecting to a computer with a USB interface, just use MIDI interface: first use a standard USB cable to connect Ux16 interface to the computer, and then connect W8822 to UX16 interface correctly.

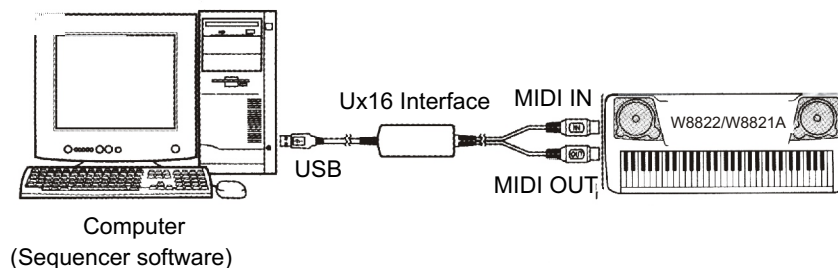

APPENDIX

VOICE LIST

This instrument has 64-note maximum polyphony. This means that it can play a maximum of up to 64 notes at once, regardless of what functions are used. Auto Accompaniment uses a number of the available notes, so when Auto Accompaniment is used the total number of available notes for playing on the keyboard is correspondingly reduced. The same applies to the Split Voice and Song functions.

Caution: The Voice List includes MIDI program change numbers for each voice. Use these program change numbers when playing this instrument via MIDI from an external device.

Voice No	MIDI No	Name of Voice	中文名称
PIANO 钢琴			
01	0	ACOUSTIC GRAND PIANO	原声大钢琴
02	1	BRIGHT ACOUSTIC PIANO	亮原声钢琴
03	2	ELECTRIC GRAND PIANO	电子大钢琴
04	3	HONKY-TONK PIANO	酒吧钢琴
05	4	ELECTRIC PIANO1	电钢琴1
06	5	ELECTRIC PIANO2	电钢琴2
07	6	HARPSICHORD	拨弦古钢琴
08	7	CLAV1	击弦古钢琴
CHROMATIC PERCUSSION 打击乐器			
09	8	CELESTA	钢片琴
10	9	GLOCKENSPIEL	钟琴
11	10	MUSIC BOX	音乐盒
12	11	VIBRAPHONE	振琴
13	12	MARINBA	马林巴
14	13	XYLOPHONE	木琴
15	14	TUBULAR BELLS	管钟
16	15	DULCIMER	洋琴
ORGAN 风琴			
17	16	DRAWBAR ORGAN	卓芭风琴
18	17	PERCUSSIVE ORGAN	打击风琴
19	18	ROCK ORGAN	摇滚风琴
20	19	CHURCH ORGAN	教堂风琴
21	20	FEED ORGAN	簧片风琴
22	21	ACCORDION	手风琴
23	22	HARMONICA	口琴
24	23	TANGO ACCORDION	探戈手风琴
GUITAR 吉它			
25	24	ACOUSTIC GUITAR(NYLIN)	尼龙弦吉它
26	25	ACOUSTIC GUITAR(STEEL)	钢弦吉它
27	26	ELECTRNIC GUITAR(JAZZ)	爵士电吉它
28	27	ELECTRNIC GUITAR(CLEAN)	清音电吉它
29	28	ELECTRNIC GUITAR(MUTED)	弱音电吉它
30	29	OVERDRIVEN GUITAR	夸张吉它
31	30	DISTOTION GUITAR	失真吉它
32	31	GUITAR HARMONICS	吉它泛音
BASS 贝司			
33	32	ACOUSTIC BASS	古典贝司
34	33	ELECTRIC BASS(FINGER)	指弹电贝司
35	34	ELECTRIC BASS(PICK)	拨片电贝司
36	35	FRETLESS BASS	无品贝司
37	36	SLAP BASS1	打弦贝司1
38	37	SLAP BASS2	打弦贝司2
39	38	SYNTH BASS1	合成贝司1
40	39	SYNTH BASS2	合成贝司2

Voice No	MIDI NO	Name of Voice	中文名称
STRINGS 弦乐			
41	40	VIOLIN	小提琴
42	41	VIOLA	中提琴
43	42	CELLO	大提琴
44	43	CONTRABASS	低音提琴
45	44	TREMOLO ATRINGS	震音弦乐
46	45	PIZZICATO STRINGS	拨奏弦乐
47	46	ORCHESTRAL HARP	竖琴
48	47	TIMPANI	定音鼓
RNSEMBLE 合奏			
49	48	STRINGS ENSEMBLE1	弦乐合奏1
50	49	STRINGS ENSEMBLE12	弦乐合奏2
51	50	SYNTH STRINGS1	合成弦乐1
52	51	SYNTH STRINGS2	合成弦乐2
53	52	CHOIR AAHS	唱音 啊
54	53	VOICE OOHS	人声 噢
55	54	SYNTH VOICE	合成成人声
56	55	ORCHESTRA HIT	管弦乐齐奏
BRASS 铜管			
57	56	TRUMPET	小号
58	57	TROMBONE	长号
59	58	TUBA	大号
60	59	MUTED TRUMPET	弱音小号
61	60	FRENCH HORN	圆号
62	61	BRASS SECTION	铜管乐队
63	62	SYNTH BRASS1	合成铜管乐1
64	63	SYNTH BRASS2	合成铜管乐2
REED 簧管乐器			
65	64	SOPRANO SAX	高音萨克斯
66	65	ALTO SAX	中音萨克斯
67	66	TENOR SAX	次音萨克斯
68	67	BARTION SAX	低音萨克斯
69	68	OBOE	双簧管
70	69	ENGLISH HORN	英国管
71	70	BASSOON	巴松管
72	71	CLARINET	单簧管
PIPE 木管乐器			
73	72	PICCOLO	短笛
74	73	FLUTE	长笛
75	74	RECORDER	竖笛
76	75	PAN FLUTE	排箫
77	76	BLOWN BOTTLE	吹瓶
78	77	SHAKUHACHI	尺八
79	78	WHISTLE	口哨
80	79	OCARINA	奥卡利那笛

VOICE LIST

Voice No	MIDI No	Name of Voice	中文名称
SYNTH REED 合成管乐器			
81	80	LEAD1(WOUIARE)	方波管乐
82	81	LEAD2(SAWTIITH)	锯齿波管乐
83	82	LEAD3(CALLIOPE)	蒸汽琴管乐
84	83	LEAD4(CHIFF)	雪坊管乐
85	84	LEAD5(CHARANG)	沙朗管乐
86	85	LEAD6(VOICE)	人声管乐
87	86	LEAD7(FIFTH)	五度管乐
88	87	LEAD8(BASS+LEAD)	贝司管乐
SYNTH PAD合成背景音色			
89	88	PAD1(NEW AGE)	新世纪垫
90	89	PAD2(WARM)	温暖音色垫
91	90	PAD3(POLYSYNTH)	聚合成音色垫
92	91	PAD4(CHOIR)	唱诗垫
93	92	PAD5(BOWED)	弓弦音色垫
94	93	PAD6(METALLIC)	金属音色垫
95	94	PAD7(HALO)	环形音色垫
96	95	PAD8(SWEEP)	掠扫音色垫
SYNTH EFFECTS合成效果音色			
97	96	FX1(RAIN)	雨
98	97	FX2(SOUNDTRACK)	声轨
99	98	FX3(CRYSTAL)	水晶
100	99	FX4(ATMOSPHERE)	大气
101	100	FX5(BRIGHTNESS)	闪亮
102	101	FX6(GOBLINS)	小妖怪
103	102	FX7(ECHOES)	回声
104	103	FX8(SCO-FI)	科幻
ETHNIC民族乐器			
105	104	SITAR	西塔尔
106	105	BANJO	班卓琴
107	106	SHAMISEN	三弦
108	107	GUZHENG	古筝
109	108	KALIMBA	卡林巴
110	109	BAGPIPE	风笛
111	110	ERHU	二胡
112	111	SUONAI	唢呐
PERCUSSION打击乐器			
113	112	TINKLE BELL	响铃
114	113	AGOGO	啊果果
115	114	STEEL DRUMS	钢鼓
116	115	WOOBLOCK	盒梆
117	116	TAIKO DRUM	日本鼓
118	117	MELODIC TOM	旋律鼓
119	118	SYNTH DRUM	合成鼓
120	119	REVERSE CYMBAL	反钹

Voice No	MIDI No	Name of Voice	中文名称
SOUND EFFECT 效果音色			
121	120	FRET NOSE	弦马杂音
122	121	BREATH NOISE	呼吸音
123	122	SEASHORE	海滨
124	123	BIRD TWEET	小鸟叫声
125	124	TELEPHONE RING	电话铃
126	125	HELICOPTER	直升飞机
127	126	APPLAUSE	喝彩
128	127	GUNSHOT	枪声
FOLK民乐音色			
129	128	YUNLUO	云锣
130	129	GUANMEILANG	甘美郎
131	130	BIANMANG	编铙
132	131	YANGQIN	扬琴
133	132	LUSHENG	芦笙
134	133	PIBA	琵琶
135	134	LUOQIN	柳琴
136	135	YUQIN	月琴
137	136	DARUAN	大阮
138	137	ZHONGRUAN	中阮
139	138	GUOHU	高胡
140	139	ERHU	二胡
141	140	ZHONGHU	中胡
142	141	ERHUQUN1	二胡群1
143	142	ERHUQUN2	二胡群2
144	143	ZHONGHUQUN	中胡群
145	144	BANGDI	梆笛
146	145	KUNDI	昆笛
147	146	XIAO	箫
148	147	BANHU	板胡
149	148	XIPI	西皮
150	149	ZHUIHU	坠胡
151	150	SANXIAN	三弦
152	151	GUZHENG	古筝
153	152	GUOYINSUONA	高音唢呐
PERCUSSION打击乐			
154	153	STANDARD DRUMS	标准鼓组
155	154	CHINESE PERCUSSION	中国打击乐组
156	155	ROOM DRUMS	房间鼓组
157	156	ROCK DRUMS	摇滚鼓组
158	157	ELECTRIC DRUMS	电子鼓组
159	158	T 808 DRUMS	T808鼓组
160	159	JAZZ DRUMS	爵士鼓组
161	160	BRUSH KIT	刷子鼓组
162	161	CLASSIC DRUMS	古典鼓组
163	162	SFX KIT	效果鼓组

STYLE LIST

No	Name	中文名
8/16BEAT 8/16拍		
00	8BEAT-1	8拍1
01	8BEAT-2	8拍2
02	8BEAT-3	8拍3
03	16BEAT-1	16拍1
04	16BEAT-2	16拍2
05	16BEAT-3	16拍3
POP 流行乐		
06	POOPROCK	流行摇滚
07	FOLKROCK	民歌风摇滚
08	POPBOLERO	流行波莱罗
09	POPWALTZ	流行华尔兹
10	SOULBALLAD	流行民谣
11	MOOTOWN	底特律节奏
DANCE 舞曲		
12	HOUSE	家庭舞曲
13	TECHNO-1	现代舞曲1
14	TECHNO-2	现代舞曲2
15	RAVE	拉布
16	DANCE-1	舞曲1
17	DANCE-2	舞曲2
18	DISCO-70S	70年代迪斯科
19	DISCO	迪斯科
20	MACARENA	马卡伦那
R&B 蓝调摇滚		
21	GOSPEL-1	黑人福音音乐1
22	GOSPEL-2	黑人福音音乐2
23	R&B-1	蓝调摇滚1
24	R&B-2	蓝调摇滚2
25	BLUES-1	布鲁斯1
26	BLUES-2	布鲁斯2
27	FUNK	早期爵士乐
ROCK 摇滚乐		
28	ROCK-60S	60年代摇滚
29	ROCK-70S	70年代摇滚
30	ROCK-80S	80年代摇滚
31	BALLROCK	舞会摇滚
32	SLOWROCK	慢摇滚
33	SLOWROCK6/8	慢摇滚6/8
ROCK&ROLL 快速摇滚乐		
34	ROCK&ROLL-1	快速摇滚1
35	ROCK&ROLL-2	快速摇滚2
36	SHUFFLE	滑曳摇滚
37	TWIST	扭扭舞
38	BOOGIE-1	布吉乐1
39	BOOGIE-2	布吉乐2
SWING/JA 摇摆舞/爵士		
40	SWING	摇摆舞
41	LOUNGE	悠闲爵士
42	DIXIE-1	新奥尔良爵士1
43	DIXIE-2	新奥尔良爵士2
44	JAZZBALLAD-1	舞会爵士乐1
45	JAZZBALLAD-2	舞会爵士乐2
46	JAZZWALTZ	爵士华尔兹
47	CHARLSTON	查尔斯顿舞
48	RAGTIME	早期爵士乐
COUNTRY 乡村音乐		

NO	Name	中文名
49	COUNTRY-1	乡村音乐1
50	COUNTRY-2	乡村音乐2
51	COUNTRYDANCE	乡村舞曲
52	COUNTRYROCK	乡村摇滚
53	COUNTRYWALTZ	乡村华尔兹
CARIBBEAN 加勒比音乐		
54	REGGAE-1	雷格1
55	REGGAE-2	雷格2
56	CARIBBEAN	加勒比节奏
LATIN-1 拉丁1		
57	BOSSA-1	波萨诺瓦1
58	BOSSA-2	波萨诺瓦2
59	SAMBA-1	桑巴1
60	SAMBA-2	桑巴2
61	RUMBA	伦巴
62	BEGUINE	贝津舞
63	CHACHA-1	恰恰1
64	CHACHA-2	恰恰2
LATIN-2 拉丁2		
65	SALSA	萨尔萨舞曲
66	CUMBIA	巴西舞曲
67	MERENQUE	美伦格舞
68	MAMBO	曼波舞曲
69	LATIN	拉丁舞曲
70	GIPSY	吉普赛舞
71	D.SAMBA	迪斯科桑巴
ORIENTAL 东方舞曲		
72	CINGENE	阿拉伯舞曲
73	MUS5/8	土耳其舞曲
74	ORIENTAL	东方舞曲
75	OYUNHAVA	小亚细亚舞曲
WORLD MUSIC 世界音乐		
76	SEVILLIANA	赛尔维利亚舞曲
77	HOLLYWOOD	好莱坞
78	SP.RUMBA	西班牙伦巴
79	SP.BOLERO	西班牙波莱多
80	SIRTAKI	希腊舞曲
81	BAROQUE	巴洛克
82	HAWAII	夏威夷舞曲
BALLROOM 交谊舞曲		
83	FOXTROT	狐步舞曲
84	QUICKSTEP	快步舞
85	SLOWFOX	慢狐步舞
86	TRAD.WALTZ	传统华尔兹
87	JIVE	轻快爵士
88	PASODOBLE	平舞土舞
89	TANGO	探戈
90	TANGOARG	阿根廷探戈
WALTZ/MARCH 华尔兹进行曲		
91	GERMWALTZ	德国华尔兹
92	VIENNAWALTZ	维也纳华尔兹
93	MUSETTE	风笛舞
94	SLOWWALTZ	慢速华尔兹
95	MARCH	进行曲
96	MARCH6/8	进行曲6/8
97	POLKA	波尔卡
98	D.POLKA	迪斯科波尔卡
99	SCHLAGER	德国进行曲

DRUM SET TABLE (MIDI CHANNEL 10)

	1 HQ STD SET1	2 CHINESE SET	3 HQ ROOM SET	4 HQ POWER SET	5 HQ ELEC. SET
39 - D#2	High Q				
40 - E2	Slap				
41 - F2	Scratch Push				
42 - F#2	Scratch Pull				
43 - G2	Sticks				
44 - G#2	Square Click				
45 - A2	Metronome Click				
46 - A#2	Metronome Bell				
47 - B2	HQ STD1 Kick2		HQ Room Kick2	HQ Power Kick2	HQ Elec Kick2
48 - C3	HQ STD1 Kick1		HQ Room Kick1	HQ Power Kick1	HQ Elec Kick1
49 - C#3	Side Stick				
50 - D3	HQ STD1 Snare1		HQ Room Snare1	Gated Snare	Elec SD
51 - D#3	Hand Clap				
52 - E3	Snare Drum 2		HQ Room Snare1	HQ Power Snare1	HQ Elec Snare1
53 - F3	HQ Low Floor Tom	大鼓 1	HQ Power Low Tom2	HQ Power Low Tom2	Elec Low Tom2
54 - F#3	Closed Hi Hat [EXC1]				
55 - G3	HQ High Floor Tom	大鼓 2	HQ Power Low Tom1	HQ Power Low Tom1	Elec Low Tom1
56 - G#3	Pedal Hi-Hat [EXC1]				
57 - A3	HQ Low Tom	中鼓 1	HQ Power Mid Tom2	HQ Power Mid Tom2	Elec Mid Tom2
58 - A#3	Open Hi-Hat [EXC1]				
59 - B3	HQ Low-Mid Tom	中鼓 2	HQ Power Mid Tom1	HQ Power Mid Tom1	Elec Mid Tom1
60 - C4	HQ Hi Mid Tom	小鼓 1	HQ Power Hi Tom2	HQ Power Hi Tom2	Elec Hi Tom2
61 - C#4	Crash Cymbal 1				
62 - D4	HQ High Tom	小鼓 2	HQ Power Hi Tom1	HQ Power Hi Tom1	Elec Hi Tom1
63 - D#4	Ride Cymbal 1				
64 - E4	Chinese Cymbal	小堂锣			Reverse Cymbal
65 - F4	Ride Bell	汤锣 1			
66 - F#4	Tambourine	闭小钹			
67 - G4	Splash Cymbal	汤锣 2			
68 - G#4	Cowbell	哑锣			
69 - A4	Crash Cymbal 2	低音堂锣			
70 - A#4	Vibraslap	大堂锣			
71 - B4	Ride Cymbal 2	开小钹			
72 - C5	Hi Bongo				
73 - C#5	Low Bongo				
74 - D5	Mute Hi Conga				
75 - D#5	Open Hi Conga				
76 - E5	Low Conga				
77 - F5	High Timbale	腰鼓 1			
78 - F#5	Low Timbale	腰鼓 2			
79 - G5	High Agogo	木鱼			
80 - G#5	Low Agogo	梆子			
81 - A5	Cabasa				
82 - A#5	Maracas				
83 - B5	Short Whistle[EXC2]				
84 - C6	Long Whistle[EXC2]				
85 - C#6	Short Guiro [EXC3]				
86 - D6	Long Guiro [EXC3]				
87 - D#6	Claves				
88 - E6	Hi Wood Block				
89 - F6	Low Wood Block				
90 - F#6	Mute Cuica [EXC4]				
91 - G6	Open Cuica [EXC4]				
92 - G#6	Mute Triangle [EXC5]				
93 - A6	Open Triangle [EXC5]				
94 - A#6	Shaker				
95 - B6	Jingle Bell				
96 - C7	Belltree				

DRUM SET TABLE (MIDI CHANNEL 10)

	6 HQ TR808 SET	7 HQ DANCE SET	8 BRUSH	9 ORCHESTRA	10 SFX SET
39 - D#2				Closed Hi Hat	*
40 - E2				Pedal Hi-Hat	*
41 - F2				Open Hi Hat	*
42 - F#2				Ride Cymbal	*
43 - G2					*
44 - G#2					*
45 - A2					*
46 - A#2					*
47 - B2	HQ 909 BD	HQ Dance Kick	Jazz BD2	Concert BD 2	*
48 - C3	HQ 808 BD	HQ Elec Kick2	Jazz BD1	Concert BD 1	*
49 - C#3	808 Rim shot				*
50 - D3	808 Snare Drum	HQ Dance snare1	Brush Tap	Concert SD	*
51 - D#3			Brush Slap	Castanets	High Q
52 - E3	HQ 909 Snare	HQ Dance snare2	Brush Swirl	Concert SD	Slap
53 - F3	808 Low Tom2	Elec Low Tom2		Timpani F	Scratch Push
54 - F#3	808 CHH [EXC1]	808 CHH [EXC1]		Timpani F#	Scratch Pull
55 - G3	808 Low Tom2	Elec Low Tom1		Timpani G	Sticks
56 - G#3	808 CHH [EXC1]	808 CHH [EXC1]		Timpani G#	Square Click
57 - A3	808 Mid Tom2	Elec Mid Tom2		Timpani A	Metronome Click
58 - A#3	808 OHH [EXC1]	808 OHH [EXC1]		Timpani A#	Metronome Bell
59 - B3	808 Mid Tom1	Elec Mid Tom1		Timpani B	Guitar Slide
60 - C4	808 Hi Tom2	Elec Hi Tom2		Timpani c	Gt Cut Noise (down)
61 - C#4	808 Cymbal			Timpani c#	Gt Cut Noise (up)
62 - D4	808 HiTom1	Elec Hi Tom1		Timpani d	Double Bass Slap
63 - D#4				Timpani d#	Key Click
64 - E4		Reverse Cymbal		Timpani e	Laughing
65 - F4				Timpani f	Screaming
66 - F#4					Punch
67 - G4					Heart Beat
68 - G#4	808 Cowbell				Footsteps1
69 - A4				Concert Cymbal2	Footsteps2
70 - A#4					Applause
71 - B4				Concert Cymbal1	Door Creaking
72 - C5					Door Closing
73 - C#5					Scratch
74 - D5	808 High Conga				Wind Chime
75 - D#5	808 Mid Conga				Car Engine Start
76 - E5	808 Low Conga				Car Breaking
77 - F5					Car Pass
78 - F#5					Car Crash
79 - G5					Police Siren
80 - G#5					Train
81 - A5					Jet Take-off
82 - A#5	808 Maracas				Helicopter
83 - B5					Starship
84 - C6					Gun Shot
85 - C#6					Machinegun
86 - D6					Lasergun
87 - D#6	808 Claves				Explosion
88 - E6					Dog
89 - F6					Horse Gallop
90 - F#6					Birds
91 - G6					Rain
92 - G#6					Thunder
93 - A6					Wind
94 - A#6					Sea Shore
95 - B6					Stream
96 - C7					Bubble
					*
					*
					*
					*

TECHNICAL SPECIFICATIONS

Keyboard

W8822: 88-key keyboard with hammer action

W8821A: 88-key standard touch response keyboard

Voice

163 PCM voices

Max polyphony note: 64 notes

Keyboard percussion: 1~9 groups

Sound effect: 1 group

Volume: 00~127

Octachord: -2~2

Phase: -7~7

Keyboard Split: left & right hand voice

Dual voice: left hand voice1, right hand voice 2

Harmony and Echo: 10 styles

DSP reverb styles: 8 styles

DSP chorus styles: 8 styles

DSP reverb and chorus send level: 00~127

DSP reverb and chorus return level: 00~127

Auto Accompaniment Function

100 styles

Accompaniment track: rhythm, bass, rhythmic chord, long chord, sentence 1 / 2

Large & small accompaniment mode

Accompaniment track setting: ON / OFF, voice, volume

Accompaniment control: SYNCHRO, Intro, Main A & B, Auto Fill A & B, ending, start / stop

Tempo: 40~240

Accompaniment volume: 00~127

Accompaniment split

• Songs

22 demo songs and 1 user song

Display

122 * 50mm large LCD screen, blue back light **Record Track**

5 record tracks

Accompaniment Mode

Normal Performance, single finger, fingered

Panel Parameter Memory Bank

8 banks, accompaniment freeze

Total Function

Transpose: -12~+12

Metronome: ON & OFF

Control Buttons

function buttons, mode button, numeric buttons 0~9, [+ / YES] and [- / NO] buttons

MIDI functions

receive and send

Auxiliary Interfaces

Earphone, auxiliary output

MIDI IN & OUT

Power Output

10W+10W

Earphone output: resistance output-32 ohm

Loudspeaker: 16.5cm*2+5cm*2, 4 ohm

Voltage: 220V AC

Packing Information

Dimension: 1320(L)*850(W)*530(H)mm

G. W.: 60kg

Complimentary Accessories

Screws, screw caps, screw washers

Power supply cable

Owners manual

*.The specifications are subject to change without prior notice.